

110BH

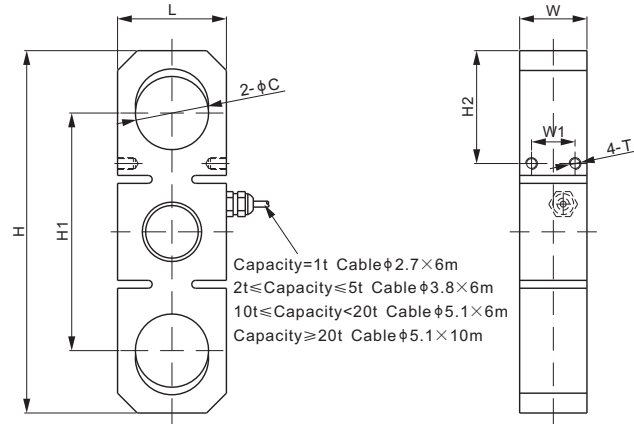

Alloy Steel; Patent Design



DIMENSIONS

RATED CAPACITY	C	H	H1	H2	L	W	W1	T	SUGGESTED SHACKLE
t/mm									
1	15.0	74.0	49.5	20.5	20.0	12.0	7.0	4-M3 Depth5	RBXS-1t or TBX-2t
2	20.0	109.5	75.5	30.5	28.0	15.0	8.0	4-M3 Depth5	SBX-3.25t
5	27.0	140.0	93.0	41.0	38.0	25.0	15.0	4-M4 Depth5	SBX-6.5t
10	37.0	183.0	120.0	57.0	55.0	34.0	22.0	4-M6 Depth8	SBX-12t
20	53.0	252.0	164.0	82.0	74.0	50.0	30.0	4-M6 Depth8	SBX-25t
30	60.0	307.5	202.0	93.0	86.0	60.0	40.0	4-M8 Depth12	SBX-35t
50	73.0	390.0	257.0	116.0	110.0	75.0	40.0	4-M12 Depth20	SBX-55t
75	88.0	486.0	324.0	147.0	135.0	90.0	60.0	4-M12 Depth20	SBX-85t
100	102.0	580.0	389.0	172.0	160.0	100.0	60.0	4-M12 Depth20	SBX-120t
120	102.0	580.0	389.0	172.0	160.0	120.0	60.0	4-M12 Depth20	SBX-120t
lb/inches (conversion of above dimensions)									
2,204.6	0.59	2.91	1.95	0.81	0.79	0.47	0.28	4-M3 Depth0.20	RBXS-1.5t
4,409.2	0.79	4.31	2.97	1.20	1.10	0.59	0.31	4-M3 Depth0.20	SBX-3.25t
11,023.1	1.06	5.51	3.66	1.61	1.50	0.98	0.59	4-M4 Depth0.20	SBX-6.5t
22,046.2	1.46	7.20	4.72	2.24	2.17	1.34	0.87	4-M6 Depth0.31	SBX-12t
44,092.5	2.09	9.92	6.46	3.23	2.91	1.97	1.18	4-M6 Depth0.31	SBX-25t
66,138.7	2.36	12.11	7.95	3.66	3.39	2.36	1.57	4-M8 Depth0.47	SBX-35t
110,231.1	2.87	15.35	10.12	4.57	4.33	2.95	1.57	4-M12 Depth0.79	SBX-55t
165,346.7	3.46	19.13	12.76	5.79	5.31	3.54	2.36	4-M12 Depth0.79	SBX-85t
220,462.2	4.02	22.83	15.31	6.77	6.30	3.94	2.36	4-M12 Depth0.79	SBX-120t
264,554.7	4.02	22.83	15.31	6.77	6.30	4.72	2.36	4-M12 Depth0.79	SBX-120t

SPECIFICATIONS

Full Scale Output	3.0 mV/V ± 10%	Recommended Excitation	10V (15V Maximum)
Zero Balance	±0.02 mV/V	Insulation Resistance	>2 [50V DC] GΩ
Non-linearity	<±0.017%	Compensated Temperature Range	-10°C to 50°C / 14°F to 122°F
Repeatability	<±0.017%	Safe Overload	150% of full scale
Hysteresis Error	<±0.017%	Breaking Overload	300% of full scale
Creep in 30 min.	<±0.023%	Seal Type / IP Rating	Environmentally Sealed / IP67
Input Resistance	400Ω ±20	Cable Color Code	Exc+ Red Exc- Black
Output Resistance	350Ω ±3		Sig+ Green Sig- White
Element Material	Alloy Steel, Nickel Plated		Shield Bare

PART NUMBER

Rated Capacity	Part No.	Weight (kg) Approx.
1t	110BH-1t	0.2
2t	110BH-2t	0.4
5t	110BH-5t	0.8
10t	110BH-10t	2.4
20t	110BH-20t	5.4
30t	110BH-30t	9.3
50t	110BH-50t	22.0
75t	110BH-75t	35.4
100t	110BH-100t	54.8
120t	110BH-120t	61.0

WEIGH MODULE

Model	Page
110BHM3	138



1t-2t: NTEP 1:3 000 Class III, Single Cell;
 NTEP 1:5 000 Class III, Multiple Cell;
 5t-50t: NTEP 1:3 000, up to 1:6 000 Class III, Single Cell and Multiple Cell



1t-10t: OIML MAA C3, Y=15 000
 10t-50t: OIML MAA C3, up to C6, Y=13 500