

Technical Manual

The 808 Series Industrial Remote Display



ANYLOAD[®]

TABLE of CONTENTS:

1.	INTRODUCTION	2
1.1	Main Features	2
1.2	Technical Specifications	3
2.	INSTALLATION	4
2.1	Safety Precautions	4
2.2	Main Enclosure	5
2.3	Opening Enclosure	6
2.4	Wall Mounting	7
2.5	Pole Mounting	7
3.	WIRING	8
3.1	Controller Board Terminals	8
3.2	Electrical Power Wiring	9
3.3	Serial Communication Wiring	10
3.4	Multiple Display Wiring	10
3.5	Switch and Relay Wiring	12
4.	CONFIGURATION	13
4.1	Function Setup Menu	13
4.2	Operating Modes	13
4.3	Membrane Keypad	14
4.4	F1 Display Setting	16
4.5	F2 Utility Setting	17
4.6	F3 Protocol Setting	18
4.7	F4 Communication Setting	19
4.8	F5 Auxiliary Setting	20
5.	TROUBLESHOOTING	21
5.1	Controller Board	21
5.2	Error Codes	22
5.3	Display Messages	22
5.4	Push Buttons	22
5.5	Diagnostic Lights	23
5.6	Advance Diagnostic	23
5.7	Protocol Example	24
5.8	Multiple Display	24

I. ABOUT THIS MANUAL

Thank you for choosing Anyload 808AH industrial remote display. This 808AH technical manual provides installation, setup, operation, and configuration information for the 808AH industrial remote display. This manual is intended to be used by trained service technicians and installers. It is recommended to go through the manual in details before installing, operating or configuring the instrument. For further information please contact Anyload Weigh & Measure Inc. authorized dealer.

II. DISCLAIMER



Information in this Technical Manual is subject to change without notice due to correction or enhancement. The information described in this manual is the property of Anyload Weigh & Measure Inc. All other brand or product names within this publication are trademarks or registered trademarks of their respective companies. All information contained within this publication is, to the best of our knowledge, complete and accurate at the time of publication.

ANYLOAD[®] is a registered trademark of Anyload Weigh & Measure Inc. Copyright © 2019 Anyload Weigh & Measure Inc. All rights reserved.

III. SAFETY

Standard safety practices are required before conducting any installation, maintenance, or procedure on device. It is recommended to read and understand the instructions and warnings in this manual before performing any procedure on device. Failure to follow the instructions and warnings could result in injury or death.

Definition of the safety symbols is described in table below.

Symbol	Description
	<p>WARNING!</p> <p>Indicates a potentially hazardous situation which may result in serious injury or death Indicates a potentially dangerous procedure which may cause injury or death</p>
	<p>CAUTION!</p> <p>Indicates a potentially wrong procedure which may result in damage to device Indicates a potentially wrong procedure which may result in loss of warranty</p>
	<p>NOTICE!</p> <p>Indicates a procedure which may need more instructions Indicates a procedure which has more information available</p>

1. INTRODUCTION

1.1 MAIN FEATURES

- Designed by Anyload Weigh & Measure Inc. in Canada
- Six digits LED industrial remote display.
- High intensity, wide viewing angle, double row discrete LEDs.
- Standard seven segments with capability to display alphanumeric characters.
- Automatic learn mode to set communication baud rates.
- Automatic learn mode to detect incoming strings format.
- Ambient light sensor for day and night brightness control.
- Adjustable brightness settings for day and night.
- Software configuration for custom string formats.
- Menu driven setup function using a membrane keypad.
- Switch inputs and a relay output module to control traffic light.
- Customized software utility programs for truck axle weighing and summation.
- Customized addressable configuration to daisy chain multiple remote displays.
- Up to two decimal places with choice of dot or comma.
- Reverse digits mode for visibility in mirrors.
- Standard wall mount and pole mount kits.
- Standard sun visor and rain shade.
- Indication of GROSS (GR) or NET (NT) status by annunciators.
- Indication of KG (kg) or LB (lb) (or T (t) in other versions) units by annunciators.
- Independent ESD protected RS232, RS422/RS485 and 20mA serial communications.
- Echo out port for RS-232 and RS-422/RS-485 serial communications.
- Metal enclosure with hinged front cover for easy service.
- Weather proof mild steel powder coated enclosure.
- Internal folding electronic plate for easy wiring.
- Semitransparent grey front safety glass.
- UL approved encapsulated multi sense voltage power supply.
- Breather ventilation to avoid condensation inside enclosure.

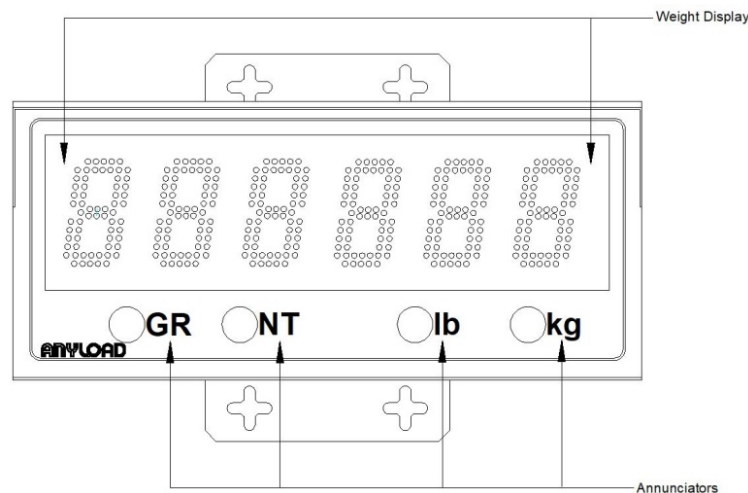

1.2 TECHNICAL SPECIFICATIONS

Item	Specification	Description
1	Display Digits	5" (125mm) height, 6 digits, 7 segments,
2	Digit Segments	1500mcd high intensity brightness, 120° viewing angle, discrete red CREE [®] LED
3	Micro Controller	50MHZ ARM Cortex M [®] processor
4	Status Indication	4 annunciators for GR, NT, lb and kg (some versions in kg and t)
5	Decimal Point	2 decimal point places with choice of dot or coma
6	Membrane Keypad	4 keys dome membrane keypad
7	Brightness Control	550nm ambient light sensor to adjust brightness in day and night
8	Communication Ports	3 independent serial ports for RS232, RS422/RS485, and 20mA current loop
9	Communication Baud	Auto learn 300,600,1200,2400,4800,9600,19200,38400,57600 baud rate
10	String Protocol	Auto learn to detect string protocol and parse incoming string
11	Echo Port	2 independent serial ports for RS232 and RS422/RS485
12	Printer Port	1 independent transmit port for none legal for trade printing applications
13	Digital Output	1 form C relay output rated at 2A / 60VDC
14	Digital inputs	2 independent dry contact switch inputs
15	Main Enclosure	Mild steel powder coated NEMA 4 / IP65 weather proof suitable for outdoor applications
16	Power Supply	Input: 100-240VAC, 1.2A, 50/60Hz / output: 12VDC, 5.0A, 60W encapsulated
17	Power Consumption	120VAC @ 0.5A / 12VDC @ 2.5A (60W AC / 30W DC) typical
18	Operating Temperature	-40°F to 120°F (-40°C to 50°C)
19	Operating Humidity	20%RH to 90%RH
20	Enclosure Ventilation	GORE [®] breather vent to avoid condensation
21	Physical Dimensions	22.8" W X 9.8" H X 5.9" D (579mm X 250mm X 149mm)
22	Total Weight	7.5 kg (17 lb) main unit and 1.5 kg (3 lb) mounting kits, approximately
23	Industry Approvals	UL / CUL approved class II power supply, CB CE
24	Limited Warranty	2 years limited



2. INSTALLATION

2.1 SAFETY PRECAUTIONS

Please practice safety before conducting any installation, maintenance, or procedure on device.

- ✓ The 808AH remote displays are pre-wired AC devices with multi sense voltage.
- ✓ It is necessary to practice safety checks before any installation or maintenance.
- ✓ Do not operate this device unless all instructions in this manual have been read.
- ✓ All installation and maintenance shall be conducted by trained service technicians.
- ✓ Avoid any alteration or changes to the device other than factory provided options.
- ✓ Disconnect power source before any installation or maintenance.
- ✓ Make sure proper grounding is provided at the site.
- ✓ Make sure device is properly grounded if custom wiring is provided.
- ✓ Make sure site structure can bear weight of the remote display.
- ✓ Make sure enough clearance is available around the device for accessibility.
- ✓ Make sure all warning signs are visible and not damaged or altered.
- ✓ Follow warning and caution notes in this manual.



Symbol	Description
	<p>WARNING!</p> <p>Make sure the power source is disconnected before any installation Make sure the site has proper grounding</p>
	<p>CAUTION!</p> <p>Any unauthorized change or alteration in default wiring may void warranty Any installation and wiring must be handled by authorized personnel</p>
	<p>NOTICE!</p> <p>Refer to the local electrical code for the wiring color codes Refer to the installation section for instructions to how to access to the wiring terminals</p>

2.2 MAIN ENCLOSURE

The main enclosure is a hinged design metal enclosure protected by two toggle latches on the sides for easy service. The enclosure is a weather proof mild steel powder coated with both standard pole mount and wall mount brackets included in the package. All internal parts are installed on a folding metal plate mounted inside of the enclosure.

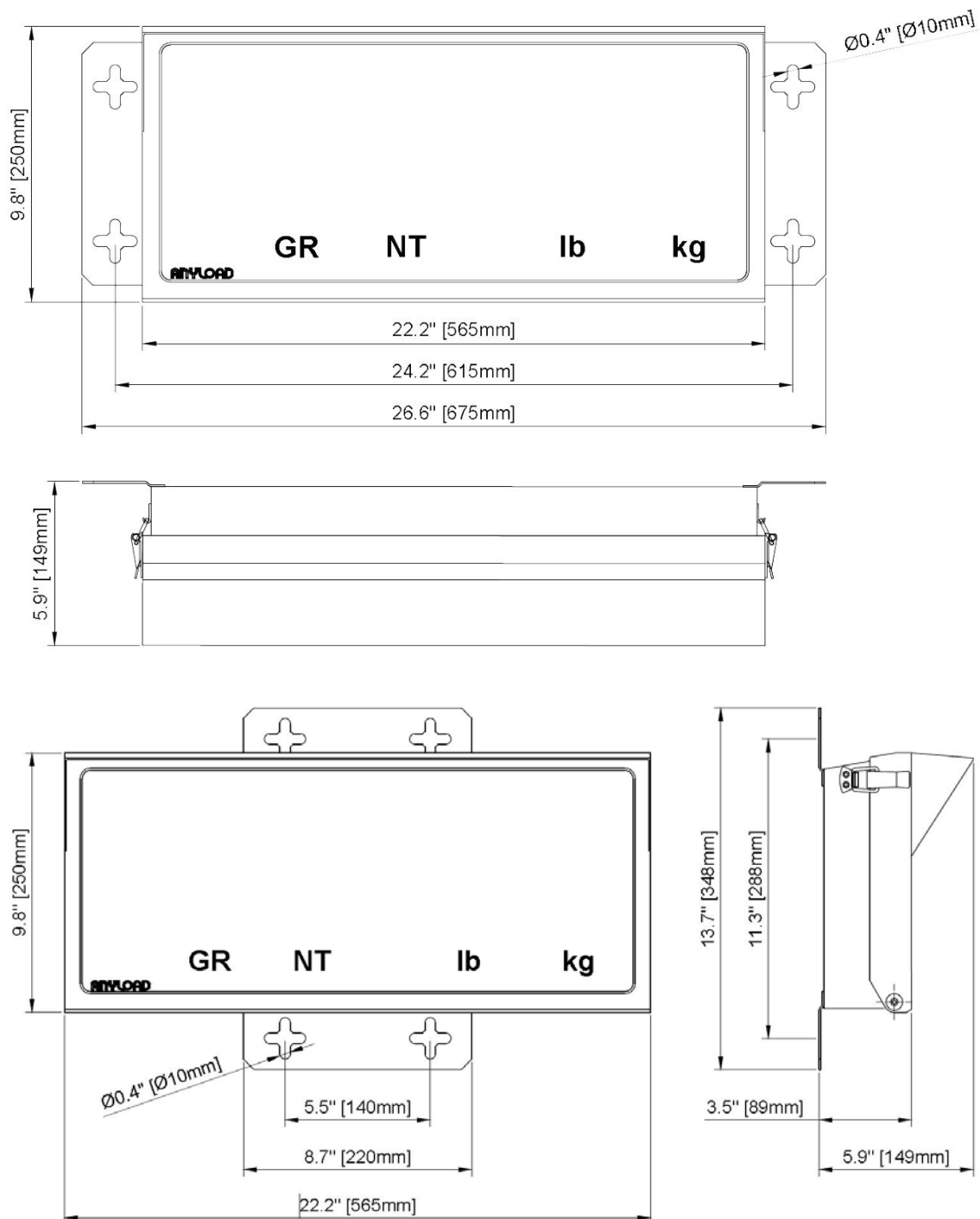

2.3 OPENING ENCLOSURE

To open the cover, unlatch the two toggle latches on both sides of the enclosure and flip down the hinged front cover. To access the electronic components, loosen two retention screws on each sides of the electronic plate of the 808AH remote display.

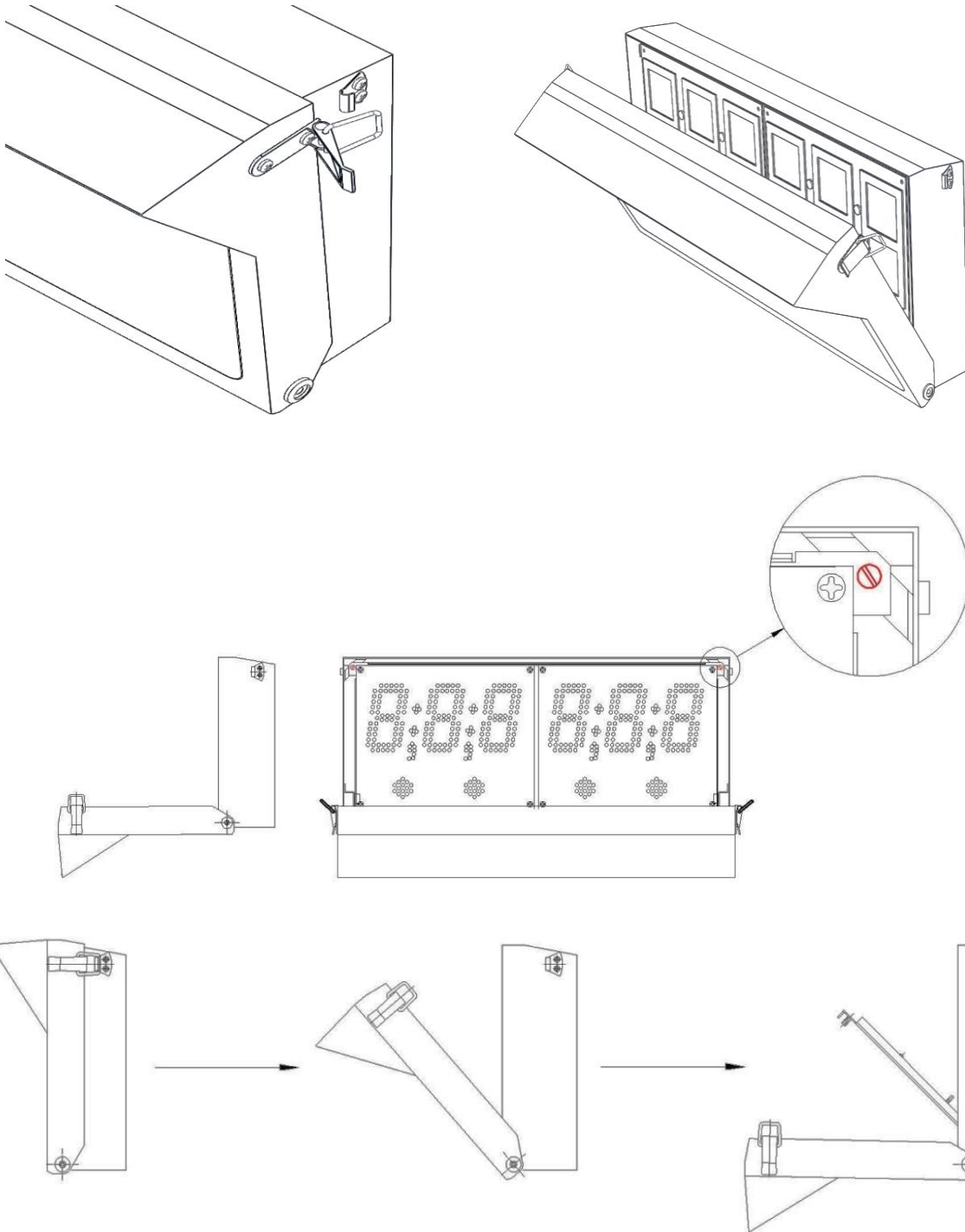

2.4 WALL MOUNTING

The 808AH remote displays may be mounted on walls with standard ear mount pieces provided in the package. The ear mount pieces can be attached to the main enclosure by six philips type screws.

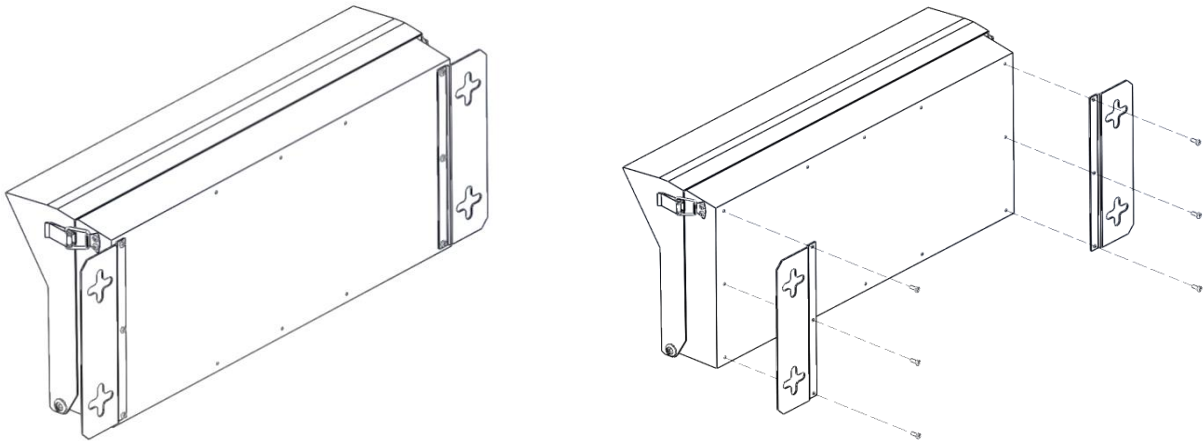

2.5 POLE MOUNTING

The 808AH remote displays may be mounted on the poles by standard pole mount kit provided in the package. The pole mount kit includes two ear mount pieces (connected to the main enclosure by six Philips screws) and a pole mount. Have the pole mount fixed on the pole first, then install the enclosure (with the ear mount pieces attached) on it.

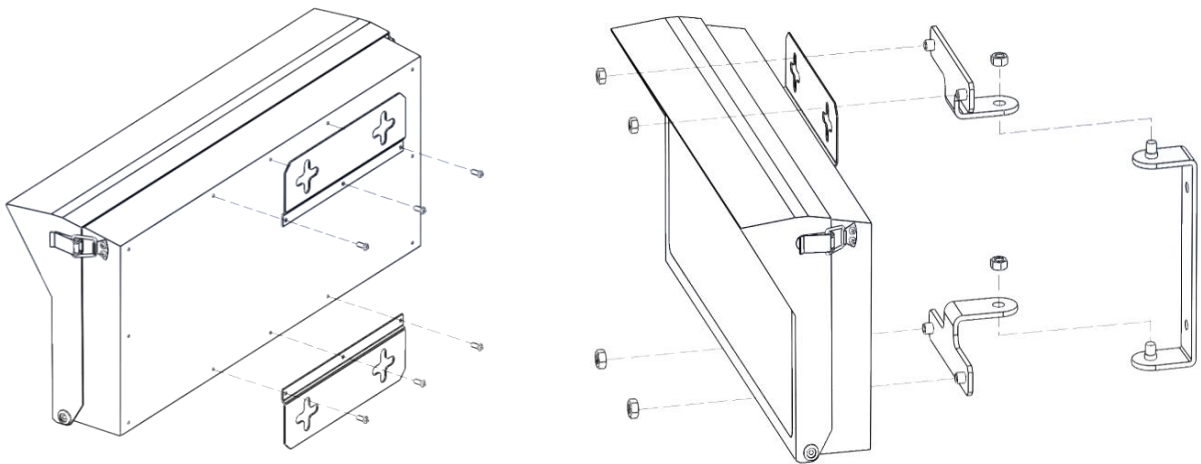

3. WIRING

3.1 CONTROLLER BOARD TERMINALS

All communication signals, switch inputs, and outputs can be terminated to the controller board via accessible screw terminals. These terminals are designed to accept serial data communication signals, dry contact switch inputs, and a relay output.

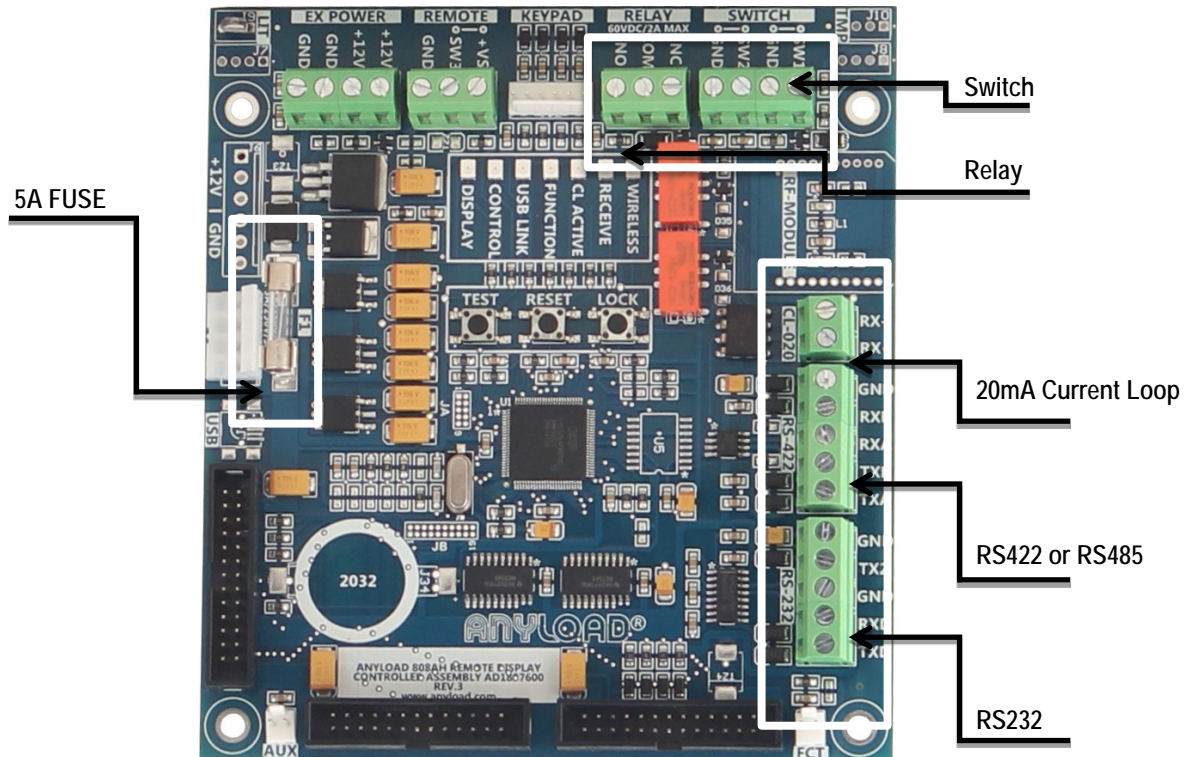

Item	Protocol	Distance
1	RS-232	50 feet (15 m)
2	RS-422/RS-485	1000 feet (300 m)
3	20mA	500 feet (150 m)

Symbol	Description
	<p>NOTICE!</p> <p>Availability of the options is subject to confirmation by manufacturer and may vary by firmware version Refer to the configuration section for instructions on how to configure the functions of remote display Refer to the installation section for instructions on how to access the wiring terminals</p>



3.2 ELECTRICAL POWER WIRING

The 808AH remote displays are pre-wired AC devices with regional power cable cord installed via strain reliefs. The proper grounding is provided as default. The standard 808AH remote displays do not have any ON / OFF power switch. Therefore, before any installations, make sure all power sources are disconnected.

It is required to use a ground fault circuit interrupter to supply AC lines to the device at the site to avoid any risk or hazard. For the applications requiring custom wiring, all safety precautions and proper grounding must be considered. This table is based on color codes commonly used in North America. For other regions, the local codes must be obtained and observed.

Power Cord		Power Supply	
Wire	Color	Color	Wire
Neutral	White	Blue	N
Live	Black	Brown	L
	Green	-	

Item	AC Power Supply	Description
1	Input	AC 100-240V~ 1.2A 50-60HZ
2	Output	DC 12V 5A 60W
3	Enclosure	Encapsulated IP67
4	Protection	Short circuit, Over load, Over voltage
5	Approval	Class II UL / CUL approved, CB CE

Symbol	Description
	WARNING! Make sure the power source is disconnected before any installation Make sure the site has proper grounding
	CAUTION! Any unauthorized change or alteration in default wiring may void warranty Any installation and wiring must be handled by authorized personnel
	NOTICE! Refer to the local electrical code for the wiring color codes Refer to the installation section for instructions to how to access to the wiring terminals

3.3 SERIAL COMMUNICATION WIRING

The 808AH remote displays provide industry standard serial communication ports with installation via screw terminals. The ports are automatically detected and adjusted upon start up. There are three communication ports available as RS-232, RS-422, RS-485, and 20mA current loop in both active and passive mode. The serial communication wires coming from indicator shall be entered to the unit via bottom strain reliefs and be terminated to the proper terminals.

Communication	Indicator	808AH	Description
Protocol	RS-232	RS-232	Function
RS-232 Communication RS-232 Printer Port	-	GND	Signal Ground
	-	TX2	Printer Port Transmit Data
	GND	GND	Signal Ground
	TX	RXD	Transmit to Receive Data
	-	TXD	Transmit Data

Communication	Indicator	808AH	Description
Protocol	RS-485	RS-422	Function
RS-422 Communication RS-485 Communication	GND	GND	Signal Ground
	TXB	RXB	Negative Transmit to Negative Receive Data
	TXA	RXA	Positive Transmit to Positive Receive Data
	-	TXB	Negative Transmit Data
	-	TXA	Positive Transmit Data

Communication	Indicator	808AH	Description
Protocol	20mA	CL-20	Function
20mA Current Loop Passive or Active	TX-	RX-	Negative Transmit to Negative Receive Data
	TX+	RX+	Positive Transmit to Positive Receive Data

Symbol	Description
	<p>NOTICE!</p> <p>Availability of the printer port is subject to confirmation by manufacturer and may vary by firmware version Refer to the F4 section for instructions on how to configure communication ports of remote display Refer to the F4 section for instructions on how to configure passive or active mode of 20mA port Refer to the installation section for instructions on how to access the wiring terminals</p>

3.4 MULTIPLE DISPLAY WIRING

Depending on the application and distances, one of the following methods can be used for multiple remote displays in a multi-drop mode. Up to ten 808AH remote displays can be wired in multi scale mode. Echo out ports functionality is disabled as default and can be activated in setup menu. The table below shows the wiring and configuration of fours remote displays.

808AH Multi Display	Indicator	808AH #1	808AH #2	808AH #3	808AH #4
Protocol	RS-232	RS-232/RS422	RS-422	RS-422	RS-422
RS-232 TO RS-422 / RS-485	TXD	RXD	-	-	-
	RXD	-	-	-	-
	-	TXA	RXA	RXA	RXA
	-	TXB	RXB	RXB	RXB
	GND	GND	GND	GND	GND

808AH Multi Display	Indicator	808AH #1	808AH #2	808AH #3	808AH #4
Protocol	RS-422	RS-422	RS-422	RS-422	RS-422
RS-422 / RS-485 TO RS-422 / RS-485	TXA	RXA	RXA	RXA	RXA
	TXB	RXB	RXB	RXB	RXB
	GND	GND	GND	GND	GND

808AH Multi Display	Indicator	808AH #1	808AH #2	808AH #3	808AH #4
Protocol	RS-232	RS-232	RS-232	RS-232	RS-232
RS-232 TO RS-232	TXD	RXD	-	-	-
	-	TXD	RXD	-	-
	-	-	TXD	RXD	-
	-	-	-	TXD	RXD
	GND	GND	GND	GND	GND

Symbol	Description
	<p>NOTICE!</p> <p>Availability of the utility programs are subject to confirmation by manufacturer and may vary by firmware Refer to the F2 section for instructions on how to configure multiple remote displays Refer to the F4 section for instructions on how to configure echo out ports Refer to the installation section for instructions on how to access the wiring terminals</p>

3.5 SWITCH AND RELAY WIRING

The input switches SW1 and SW2 can be used to control the output relay and also to control the display to show prompt messages as set. The input switches are designed to accept both momentary and toggle switches. The switches only accept dry contact as input configuration.

Terminal	Pin	Label	Function
SWITCH	1	SW1	Dry Contact Switch, Active Low Short to GND
	2	GND	Signal Ground
	3	SW2	Dry Contact Switch, Active Low Short to GND
	4	GND	Signal Ground

Switch 2	Switch 1	Relay	Description
---	Open (H)	NC	GREEN External Traffic Light
---	---	COM	Common for External Voltage
---	Closed (GND)	NO	RED External Traffic Light

Switch 2	Switch 1	Display	Description
Open (H)	Open (H)	None	No Message On Display
Open (H)	Closed (GND)	Message 1	Message 1 Display is Activated by SW1
Closed (GND)	Open (H)	Message 2	Message 2 Display is Activated by SW2
Closed (GND)	Closed (GND)	None	No Message on Display

Symbol	Description
	WARNING! The switches only accept dry contact as inputs The relay contact is limited to 2A/60VDC Make sure the site has proper grounding
	CAUTION! The switches only accept dry contact as inputs Any unauthorized change or alteration in default wiring may void warranty Any installation and wiring must be handled by authorized personnel
	NOTICE! The switch and relay functions are disabled as default Refer to the configuration section for instructions to how to configure inputs and outputs Refer to the installation section for instructions to how to access to the wiring terminals

4. CONFIGURATION

4.1 FUNCTION SETUP MENU

The function setup menu is consisted of different function blocks used to set different configuration values of 808AH remote displays. There are five function blocks currently available for configuration showed in the table below.

Block	Menu	Description
F1	DISPLAY	Functions Related to Digits Display
F2	UTILITIES	Functions Related to Utilities and Special Programs
F3	FORMAT	Functions Related to String Formats and Protocols
F4	SERIAL	Functions Related to Data Communications and Serial Ports
F5	AUXILIARY	Functions Related to Switch Inputs and Relay Outputs
F6	-	N/A
F7	-	N/A
F8	-	N/A
F9	DIAGNOSTIC	Advance Diagnostics

4.2 OPERATING MODES

Mode	Description
AUTOMATIC	Attempts to learn communication speed (baud) and parse string format (protocol) at start up. It is set as default and active only at start up. Once it is successful, it can be switched to other modes. Onboard FUNCTION LED will blink fast at four times a second.
PRESET	Sets the functions based on its internal directory of known communication rates and string formats. It is useful if auto learn mode has been successful. Then it can be activated to avoid unnecessary delay and changes startup. Onboard FUNCTION LED will blink normal once a second.
MANUAL	Sets the functions based on its manually set values stored in its memory. It is useful if auto learn mode has not been successful or display is not aligned correctly. Then it can be used to set communication rate and string format manually. Onboard FUNCTION LED will blink slowly once every two seconds.

4.3 MEMBRANE KEYPAD

The setup menu is used to configure main operating functions of the 808AH remote display. A four keys membrane keypad, located at bottom of the enclosure, is used to enter into, exit from, and navigate through setup menu functions.

To enter into setup menu, press and hold ◀ & ▶ keys together for two seconds. To exit from setup menu, use the same keys combination. To navigate through menus, press short or hold ◀ or ▶ keys. To enter into or exit from a sub menu press ○ key. To change a sub menu value, press ◀ or ▶ keys. To exit from setup, without saving, press and hold TEST button.

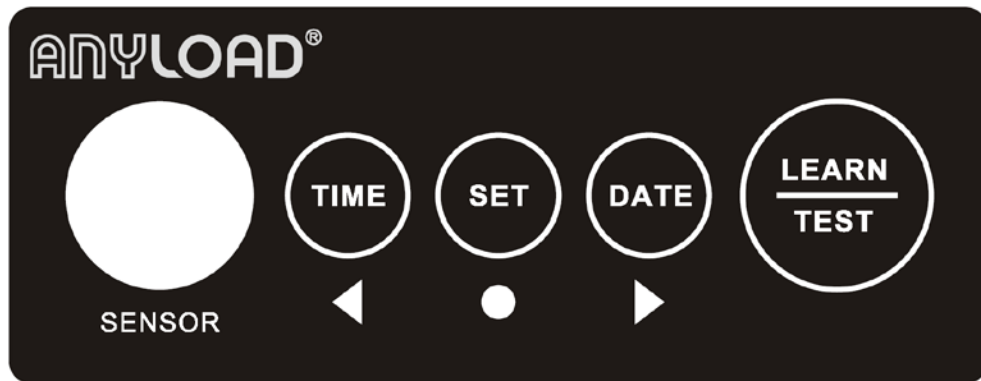

Keypad	Key	Function	Description
		Short press: LEARN Long press: TEST	LEARN: Attempts to learn communication baud and format of an incoming data. TEST: Advance testing and adjusting the display.
		Short press: FX.X - 0.1 Long press: FX.X - 1.0	LEFT : Short Press: Decrements subsection categories, FX.X. Long Press: Decrements section categories, FX.
		Short press: SET Long press: ABORT	SET: Short Press: Entering into section categories FX.X. Short Press: Accepting the value of a subsections FX.X. Long Press: Returning to section categories FX.
		Short press: FX.X + 0.1 Long press: FX.X + 1.0	RIGHT : Short Press: Increments subsection categories, FX.X. Long Press: Increments section categories, FX.

- *ENTERING INTO SETUP MENU*

Press and hold ◀ & ▶ keys together simultaneously for two seconds to enter setup menu, the SETUP message will appear. Then first function block F1.0 will be displayed.

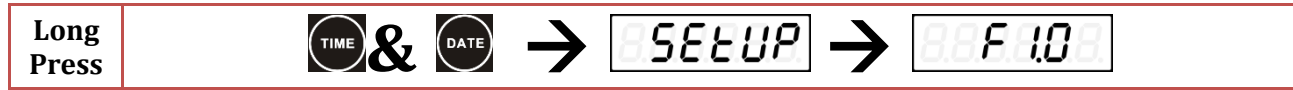

- *NAVIGATING THROUGH MENU*

To navigate through the menu, press ◀ or ▶ keys. A short press will cause FX.X to increase or decrease by 0.1 (move within the submenu) and a long press will increase or decrease by 1 (exit the submenu and go to the root menu).

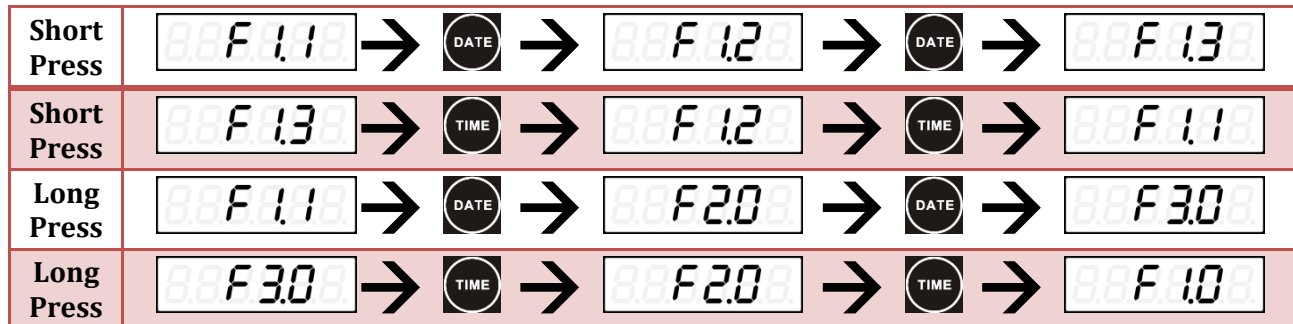

- *EDITING SUBMENU VALUES*

Press ○ key to enter the shown submenu and the current setting of that submenu will be displayed. Press ◀ or ▶ keys to change the value of the submenu as required.

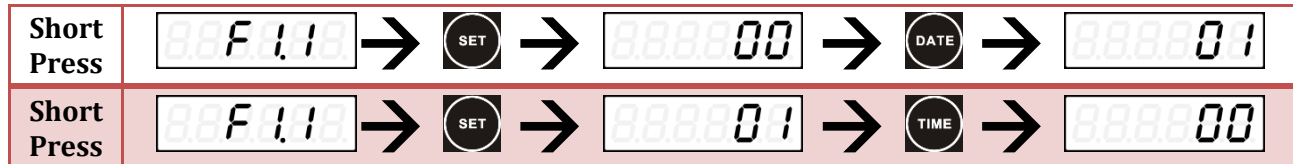

- *SETTING SUBMENU VALUE*

Press ○ key to accept the selected value and return to the submenu. A FX.X message showing corresponding function block will be displayed.



- *EXITING FROM SETUP MENU*

Press and hold ◀ & ▶ keys together simultaneously to save and exit the setup menu. A SAVED message will be displayed and then it will reset. To exit without saving, press and hold TEST button.

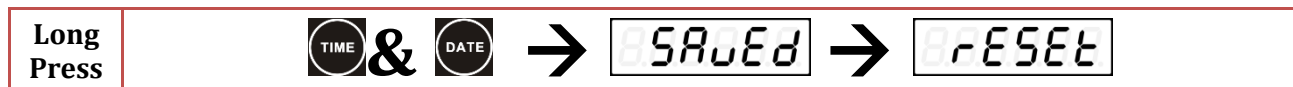

4.4 F1 DISPLAY SETTING

Function	Value	Setting	Description
F1.0 Factory Reset	0 1	Abort Factory	If set 1, remote display will reset its functions to default factory settings.
F1.1 Setup Lockout	0 1	Allowed Prevented	If set 1, any changes to settings is prevented. This is useful to disable setup menu to avoid unwanted changes.
F1.2 Energy Saving	0 1 2 3	Disabled Level 1 Level 2 Level 3	Manages energy saving by adjusting the brightness. If set 0, energy saving is disabled. If set 1, display reduces brightness if no activity on display for 15 min. If set 2,3, display reduces brightness if scale weight at 0 for 15 min.
F1.3 Day / Night Brightness Control	0 1	Disabled Enabled	If set 0, brightness level is always set to day time level. If set 1, light sensor is active and monitors day and night.
F1.4 Day Time Brightness Setting	100 80 50 20	100 % 80 % 50 % 20 %	Sets day time brightness level. Brightness level is shown in percentage. Daytime is monitored by onboard light sensor.
F1.5 Night Time Brightness Setting	100 80 50 20	100 % 80 % 50 % 20 %	Sets night time brightness level. Brightness level is shown in percentage. Nighttime is monitored by onboard light sensor.
F1.6 Startup Test	0 1	Disabled Enabled	Runs display test at startup as default.
F1.7 Blank On Motion	0 1	Disabled Enabled	If set 1, blanks display on motion condition.
F1.8 Mirror Display	0 1 2	Disabled Enabled Toggle	Used to reverse display to be visible in truck mirrors. If set 1, it shows display in reverse. If set 2, it toggles display in every 3 seconds. If set 0, the function is disabled.
F1.9 Filter Display	0.25 0.50 0.75 1.00	0.25 sec 0.5 sec 0.75 sec 1 sec	Sets display update refresh time in seconds. It can be used based on sensitivity of the indicator. It can be used combined with blank on motion function.

4.5 F2 UTILITY SETTING

Function	Value	Setting	Description
F2.0 Utility Programs	0	0	Utility programs used for custom applications. Special programs used for multi display applications. Availability of this function is based on firmware release. The programs availability may vary based on the firmware.
	1	1	
	2	2	
	3	3	
	4	4	
	5	5	
F2.1 Multiple Remote Address	0	Id 0	It is used in multiple display applications. Each remote display has an address in multi display applications. Address 0 is considered broadcasting data to all displays. Availability of this function is based on firmware release.
	1	Id 1	
	2	Id 2	
	3	Id 3	
	4	Id 4	
	5	Id 5	
	6	Id 6	
	7	Id 7	
	8	Id 8	
F2.2 Data Timeout Default	10	10 sec	It sets display timeout in seconds if communication is lost. It is used for regular programs as default unless mentioned otherwise. The display shows dashes or blank if received data is timed out.
	20	20 sec	
	30	30 sec	
	40	40 sec	
	50	50 sec	
	60	60 sec	
F2.3 Data Timeout Custom	0.00	0 min	It sets display timeout in minutes if communication is lost. It is used for special programs and message modes. If set 0, the display holds last showing. If none 0, the display shows dashes or blank if is timed out.
	0.25	0.25 min	
	0.50	0.5 min	
	1.00	1 min	
	1.50	1.5 min	
F2.4 Data Timeout Message	0.00	0 min	It sets display timeout in minutes if communication is lost. It is used for special programs and message modes. If set to 0.00, the display holds the last showing, otherwise, the display shows dashes or blank if it is timed out.
	0.25	0.25 min	
	0.50	0.5 min	
	1.00	1 min	
	1.50	1.5 min	
F2.5 Data Lost	0	Dashes	If communication is lost, display shows dashes or simply goes blank.
	1	Blank	
F2.6 Suppressing Zero	0	Auto	It suppresses leading zeros in strings containing leading zeros.
	1	Suppress	
F2.7 Leading Zero	0	Auto	Adds two or three leading zeros in legal for trade applications.
	1	00	
	2	000	
F2.8 Decimal Character	0	Dot	Decimal points can be displayed as dot or comma.
	1	Comma	
2.9 Over Range	000000 to 999999	000000 to 999999	The weight range can set a display maximum value. The display will show OVER if weight is out of the set range. Use short and long press keys to change value and digit respectively. If set to 000000, the Over Range function is off.

4.6 F3 PROTOCOL SETTING

Function	Value	Setting	Description
F3.0 Operating Modes	0	Auto	Auto mode attempts to learn communication protocols at startup.
	1	Preset	Preset mode uses its internal saved table to set best format.
	2	Manual	Manual mode scans regularly to find best format.
F3.1 String Length	1-50	1-50	It determines total length of an incoming string.
F3.2 Weight Position	1-50	1-50	It determines start position of weight in a string.
F3.3 Weight Length	3-50	3-50	It determines number of weight numerical characters in a string.
F3.4 End Character Main	01	SOH	It sets end character of regular strings unless is mentioned otherwise. Default is <CR>.
	02	STX	
	03	ETX	
	04	EOT	
	10	LF	
	13	CR	
F3.5 End Character Special	01	SOH	It sets end character in special programs. It used for special utility programs available in utility setting. Default is <CR>.
	02	STX	
	03	ETX	
	04	EOT	
	10	LF	
	13	CR	
F3.6 Decimal Point	<input type="text" value="Auto"/>	Auto	If set to Auto, it detects decimal point from the incoming string as default. If set to 0.0, it shows one decimal place. If set to 0.00, it shows two decimal places. If set to None, the decimal point is OFF.
	0.0	0.0	
	0.00	0.00	
	<input type="text" value="none"/>	None	
F3.7 Status Annunciators	<input type="text" value="Auto"/>	Auto	If set to Auto, it detects status from an incoming string as default. If set to GR, it locked to show gross weight. If set to NT, it locked to show net weight. If set to None, both Status Annunciators will be OFF.
	<input type="text" value="Gr"/>	GR	
	<input type="text" value="nt"/>	NT	
	<input type="text" value="none"/>	None	
F3.8 Units Annunciators	<input type="text" value="Auto"/>	Auto	If set to Auto, it detects unit from an incoming string as default. If set to lb, It locked to LB to show pounds. If set to kg, It locked to KG to show kilogram. If set to None, both Status Annunciators will be OFF.
	<input type="text" value="Lb"/>	lb	
	<input type="text" value="kg"/>	kg	
	<input type="text" value="none"/>	None	
F3.9 Over Load	<input type="text" value="Auto"/>	Auto	It determines over / under load conditions.
	OU	O	It searches O in string.
	CC	C	It searches C in string.
	EE	E	It searches E in string.
	<input type="text" value="none"/>		If set None, over cap is off.

4.7 F4 COMMUNICATION SETTING

Function	Value	Setting	Description
F4.0 Communication Mode	<input type="checkbox"/> Auto <input type="checkbox"/> baud	Auto Manual	If set to Auto, It will learn the communication baud rate at startup. If set to Manual, it uses its previously saved value to be the communication baud rate.
F4.1 Communication Port	<input type="checkbox"/> RS-232 <input type="checkbox"/> RS-422 <input type="checkbox"/> CL-020 <input type="checkbox"/> RF-900	RS232 RS422/485 20mA Loop RF Wireless	It shows currently used communication port for serial communication. It is set to RS232 as default. Wireless option is not available with this version.
F4.2 Serial Communication Baud Rate	300 600 1200 2400 4800 9600 19200 32800 57600	300 600 1200 2400 4800 9600 19200 32800 57600	It sets and shows current communication baud rate. If F4.0 set to Auto, it shows current baud rate detected. If F4.0 set to Manual, it shows current baud rate setting.
F4.3 Wireless Communication Baud Rate	2400 4800 9600 19200	2400 4800 9600 19200	It sets communication baud rate if wireless option is installed. Not available with this version. Availability of this function is based on firmware release.
F4.4 Echo Out Communication Port	<input type="checkbox"/> none <input type="checkbox"/> RS-232 <input type="checkbox"/> RS-422 <input type="checkbox"/> both	Disabled RS232 RS422 Both	It sets which COM port used to echo out data for multiple displays. It is used in multi display applications. It is disabled as default.
F4.5 Current Loop Active Mode	<input type="checkbox"/> PAS Iu <input type="checkbox"/> ACT Iu	Passive Active	It sets 20mA current loop mode to passive or active mode. Set to passive mode if the indicator supplies current as default. Set to active mode if the indicator is in passive mode. To use this function refer to indicator user manual for proper setting.

4.8 F5 AUXILIARY SETTING

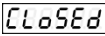
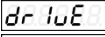
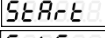
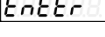
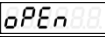
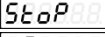
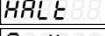
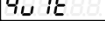
Function	Value	Setting	Description
F5.0 Switch Function	0 1 2	Disabled Momentary Latch	If set to Disable, both SW1 and SW2 are disabled as default. If set to Momentary, both SW1 and SW2 are active as push buttons. If set to Latch, both SW1 and SW2 are active in latched mode.
F5.1 Relay Function	0 1	Disabled Enabled	If set to 1, relay function is active. It operates based on SW1 current state. It is disabled as default. Refer to wiring chapter and relay section of this technical manual.
F5.2 Traffic Light Function	0	Disabled	Not available with this version. Availability of this function is based on firmware release.
F5.3 Switch 1 Message	0 1 2 3 4	Disabled    	It shows predefined messages on display if SW1 is not disabled. Refer to the wiring chapter and switch section of the manual. Default messages are as follows: CLOSED DRIVE START ENTER
F5.4 Switch 2 Message	0 1 2 3 4	Disabled    	It shows predefined messages on display if SW2 is not disabled. Refer to the wiring chapter and switch section of the manual. Default messages are as follows: OPEN STOP HALT QUIT

5. TROUBLESHOOTING

The 808AH remote displays have comprehensive tools for troubleshooting, including diagnostic lights, onboard push buttons, error codes, message codes, and advance diagnostics inside setup menu. In cases where the display is not detected, shifted, or displaced, diagnostic tools can be used to identify the problems.





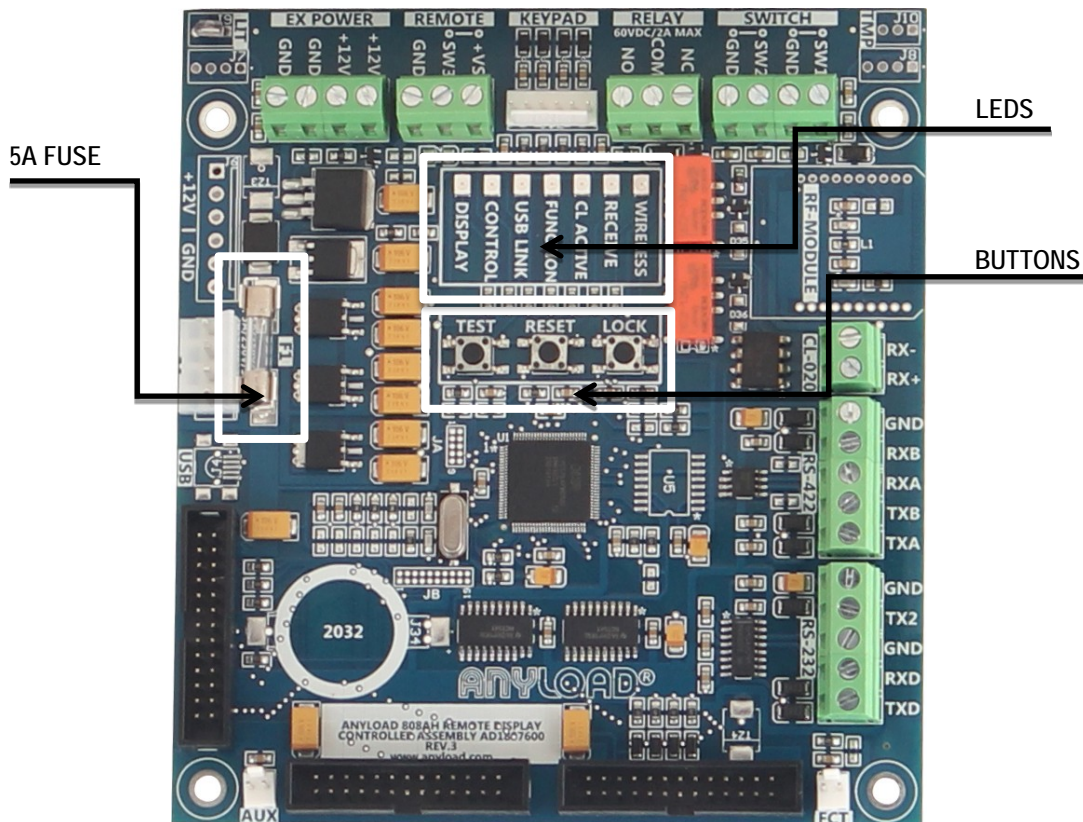

A glass type fuse is located on board to protect digit boards. It is installed on a socket and is replaceable. The fuse is rated at 5A/250V and is slow blow.

5.1 CONTROLLER BOARD

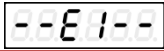





Symbol	Description
	<p>NOTICE!</p> <p>Fuse is rated at 5A/250V slow blow glass type Refer to the troubleshooting diagnostic lights and push buttons section for more information Refer to the configuration section for more information on advance diagnostic</p>

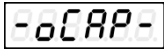

5.2 ERROR CODES

Error	Description	Action
	Communication baud rate failure	Check wirings for proper connection
	Incoming string protocol failure	Check Indicator to be in continuous mode
	Wireless communication failure	Check installed RF module
	Factory setting failure	Perform factory reset
	Memory checksum failure	Perform factory reset
	Data communication failure	Check communication setting, wiring and indicator







5.3 DISPLAY MESSAGES

Message	Description	Reason
	Shows dashes or blanks display	Data communication failure
	OCAP for over capacity on scale	Set by indicator by sending a special character
	OVER for out of range weight setting	Set by remote display in setup menu
	LEARN for auto learn baud and protocol	Auto learn mode to detect baud rate and protocol
	SAVED for saving setup information	Setup data stored in flash memory
	TEST for running a display test	Display tests segments and brightness

5.4 PUSH BUTTONS

Button	Description	Function
<p>TEST</p> 	<p>TEST</p> <p>Tests brightness levels</p> <p>Tests display segments</p> <p>Tests annunciators</p>	<p>Performs a full display test</p>
<p>RESET</p> 	<p>RESET</p> <p>Runs a cycle test</p> <p>Loads startup values</p> <p>Shows version number</p>	<p>Performs a hardware reset</p>
<p>LOCK</p> 	<p>LOCK</p> <p>Loads protocol and baud from stored values</p> <p>Avoids unnecessary delays at start up</p> <p>Locks if learn is successful at start up</p>	<p>Locks to latest successful configuration</p>

5.5 DIAGNOSTIC LIGHTS

LED	Normal	Failure
DISPLAY 	If ON, 12V display voltage is present. If OFF, 12V display voltage has failed.	If OFF check the power supply If OFF check the fuse on board
CONTROL 	If ON, 3V control voltage is present. If OFF, 3V control voltage has failed.	If OFF check the power supply
USBLINK 	USB connection.	For service and manufacturer use only
FUNCTION 	Rapid blinking four times a second (1/4sec). Normal blinking once a second (1 sec). Slow blinking once every two seconds (2 sec).	Rapid: Automatic mode Normal: Preset mode Slow: Manual mode
CLACTIVE 	If ON, 20mA loop is in active mode. If OFF, 20mA loop is in passive mode.	Passive mode is used for the indicators supplying current Active mode is used for the indicators set in passive mode
RECEIVE 	If flashing, data is being received into the buffer. If OFF, communication has failed.	If OFF check wiring and indicator Check indicator to be set in continuous mode
WIRELESS 	If ON, wireless option is working properly. It is OFF if no RF module installed.	Not available with this version

5.6 ADVANCE DIAGNOSTIC

Function	Value	Setting	Description
F9.0 Character	XXXXXX	None	Character counter Shows number of ASCII characters received in buffer
F9.1 Numeric	XXXXXX	None	Numeric counter Shows number of ASCII numeric received in buffer
F9.2 String	XXXXXX	None	String counter Shows number of complete strings received in buffer
F9.3 Checksum	XXXXXX	None	Data checksum Shows memory checksum check failure
F9.4 Signal	XX	None	RF signal strength Shows wireless signal strength if it is installed
F9.5 Sensor	XXXX	None	Light sensor indicates day light if greater than 600 Shows light sensor value a number between 0 to 1400
F9.6 Version	XX-XX	None	Displays software version
F9.7 Model	XX-XX	None	Displays model number
F9.8 Protocol	XX	None	Reserved
F9.9 Reset	0 1	Abort Initialize	Alternative setup reset Resets all setup values to default, except string settings

5.7 PROTOCOL EXAMPLE

The standard string format to be received by 808AH includes start of the text character, weight numeric values, unit character, status character, and end of the text character. An example of string protocol for single remote display application connected to an indicator is illustrated below.

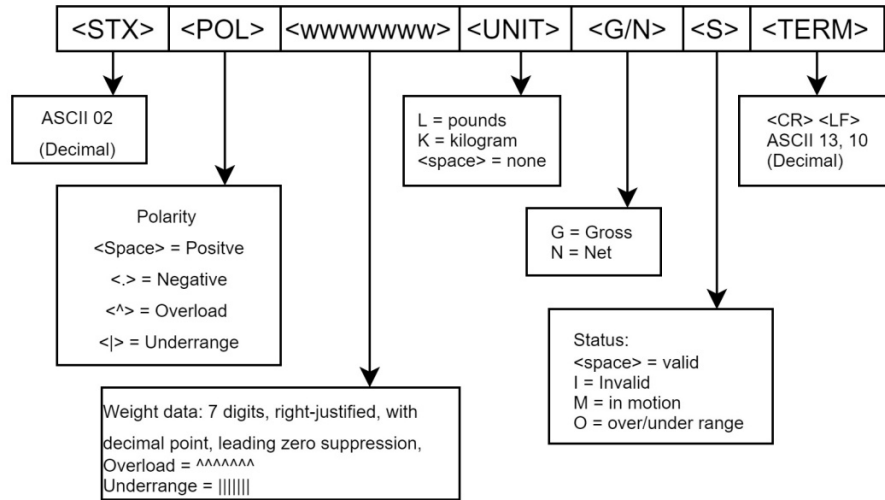

5.8 MULTIPLE DISPLAY

The 808AH remote display can be configured in a multiple display installations. Every remote display has a unique address to receive the string, and to display the weight data. This is useful in axle weighing programs, totalizing indicators, and multi scale programmable indicators. An example of string protocol for multiple remote display application including address identifier is illustrated below.

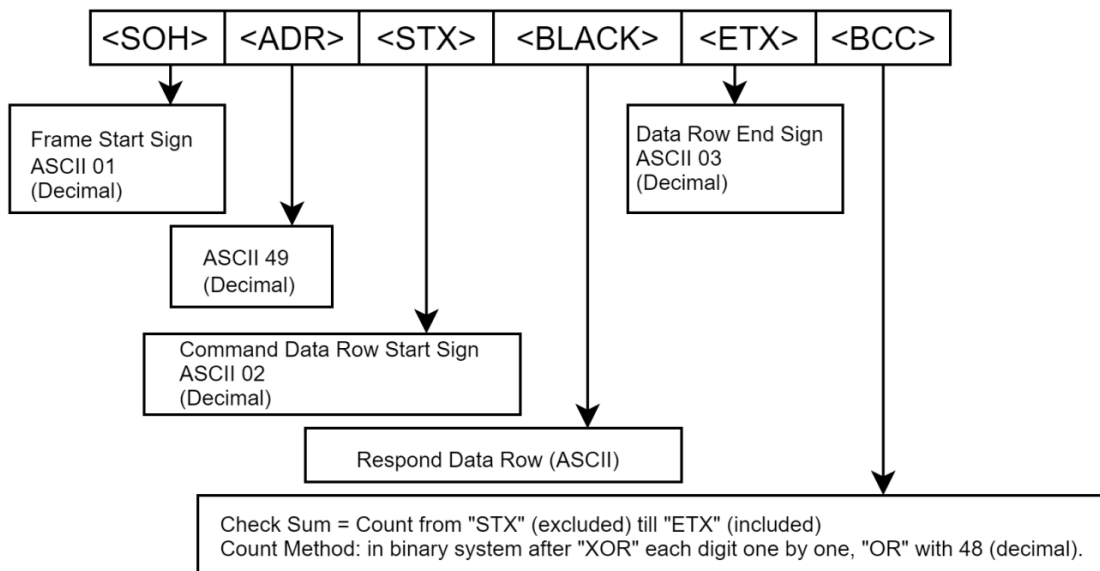

ANYLOAD®

808AH

Remote Display

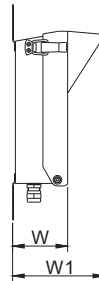
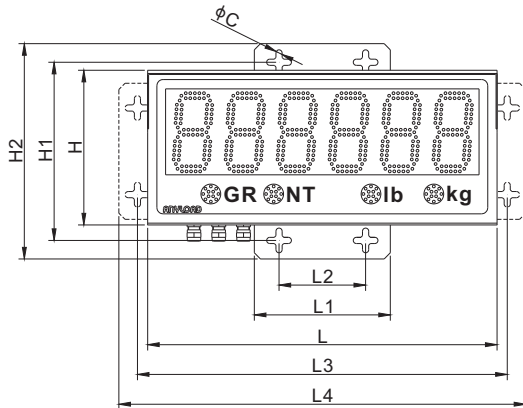

Bottom view

DIMENSIONS

	C	H	H1	H2	L	L1	L2	L3	L4	W	W1
mm	10	250	288	348	565	220	140	598	658	89	149
inches	0.4	9.8	11.3	13.7	22.2	8.7	5.5	23.5	25.9	3.5	5.9

SPECIFICATIONS

Enclosure Material	Powder Coated Mild Steel(IP65)	Power Supply	100-240VAC, 1.2A, 50/ 60Hz, UL approved
Display	6-digit, 7-segment, 125mm(5") LEDs	Operating Temp.	-40°C to 50°C (-40°F to 120°F)
Display Visibility	Max 75m(250') @1500mcd, 120° angle	Box Ventilation	Breather vent to avoid condensation
Status Indication	4 annunciators for GR, NT, lb and kg	Input & Output	2 dry contact switches and 1 form C relay
Communication	Independent RS232, RS422 / 485, 20mA 300, 600, ..., 9600, ..., 38400, 57600 Baud	Dimensions	565mm X 250mm X 89mm 22.2" X 9.8" X 3.5"

PART NUMBER

Part No.	Plug Type	Annumciators	Weight (kg) Approx.
808AH651-02.....Type B	GR, NT, lb, kg.....9.0
808AH651-02RCC.....Type I	GR, NT, kg, t.....9.0
808AH651-02RF.....Type F	GR, NT, kg, t.....9.0



ENGINEERED IN CANADA

www.anyload.com

© 2019 ANYLOAD V3 dimensions and specifications subject to change without notice

Please Contact our Authorized Dealer for Technical Assistance:

Anyload Weigh & Measure Inc.
North America Toll Free: 1.855.ANYLOAD (269.5623)
Email: info@anyload.com
www.anyload.com



9001:2015



ANYLOAD[®]