

Aluminum / Alloy Steel; Patent Design

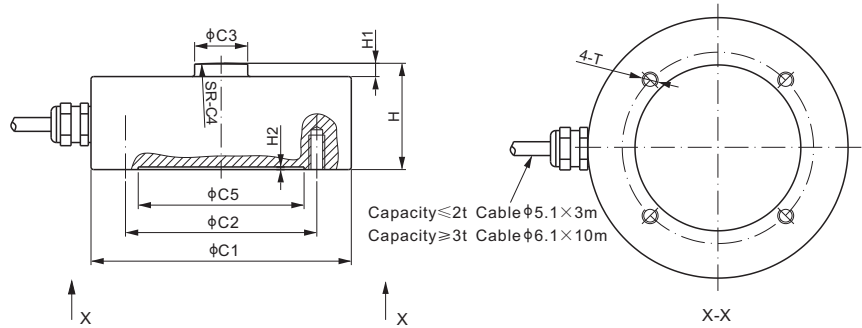

CE RoHS

Mounting hardware to be ordered separately.

DIMENSIONS

RATED CAPACITY	C1	C2	C3	C4	C5	H	H1	H2	T
266AA									
kg/mm									
25-50	62.0	55.0	12.0	50.0	36.0	22.0	4.0	1.0	M5 Depth7.0
lb/inches (conversion of above dimensions)									
55.12-110.23	2.44	2.17	0.47	1.97	1.42	0.87	0.16	0.04	M5 Depth0.28
266AH									
kg/mm									
100-2,000	62.0	55.0	12.0	50.0	36.0	22.0	4.0	1.0	M5 Depth7.0
3,000-5,000	98.0	72.0	20.0	150.0	62.4	40.0	5.0	1.0	M6 Depth13.0
10,000	98.0	72.0	20.0	150.0	62.4	45.0	5.0	1.0	M6 Depth13.0
20,000	118.0	90.0	20.0	250.0	62.4	50.0	5.0	1.0	M8 Depth15.0
30,000	138.0	115.0	20.0	250.0	62.4	73.0	8.0	1.0	M10 Depth15.0
lb/inches (conversion of above dimensions)									
220.5-4,409.2	2.44	2.17	0.47	1.97	1.42	0.87	0.16	0.04	M5 Depth0.28
6,613.9-11,023.1	3.86	2.83	0.79	5.91	2.46	1.57	0.20	0.04	M6 Depth 0.51
22,046.2	3.86	2.83	0.79	5.91	2.46	1.77	0.20	0.04	M6 Depth0.51
44,092.5	4.65	3.54	0.79	9.84	2.46	1.97	0.20	0.04	M8 Depth0.59
66,138.7	5.43	4.53	0.79	9.84	2.46	2.87	0.31	0.04	M10 Depth0.59

SPECIFICATIONS

Full Scale Output	2.0 mV/V $\pm 1\%$	Recommended Excitation	10V (15V Maximum)
Zero Balance	$\leq \pm 0.02$ mV/V	Insulation Resistance	$> 2 [50V DC] G\Omega$
Non-linearity	Cap. $\leq 2t$: $\leq \pm 0.2\%$; Cap. $\geq 3t$: $\leq \pm 0.05\%$	Compensated Temperature Range	-10°C to 50°C / 14°F to 122°F
Repeatability	Cap. $\leq 2t$: $\leq \pm 0.03\%$; Cap. $\geq 3t$: $\leq \pm 0.03\%$	Safe Overload	150% of full scale
Hysteresis Error	Cap. $\leq 2t$: $\leq \pm 0.1\%$; Cap. $\geq 3t$: $\leq \pm 0.05\%$	Breaking Overload	300% of full scale
Creep in 30 min.	Cap. $\leq 2t$: $\leq \pm 0.1\%$; Cap. $\geq 3t$: $\leq \pm 0.05\%$	Seal Type / IP Rating	266AA: Environmentally Sealed / IP66 266AH: Welded Seal / IP67
Input Resistance	Cap. $\leq 2t$: $400\Omega \pm 20$; Cap. $\geq 3t$: $770\Omega \pm 30$	Cable Color Code	Exc+ Red Exc- Black Sig+ Green Sig- White Shield Bare
Output Resistance	Cap. $\leq 2t$: $350\Omega \pm 3$; Cap. $\geq 3t$: $700\Omega \pm 5$		
Element Material	Aluminum / Alloy Steel, Nickel Plated		

PART NUMBER

Rated Capacity	Part No.	Weight (kg) Approx.
25kg.....	266AA-25kg.....	0.3
50kg.....	266AA-50kg.....	0.3
100kg.....	266AH-100kg.....	0.5
200kg.....	266AH-200kg.....	0.5
300kg.....	266AH-300kg.....	0.5
500kg.....	266AH-500kg.....	0.5
1t.....	266AH-1t.....	0.5
2t.....	266AH-2t.....	0.5
3t.....	266AH-3t.....	2.4
5t.....	266AH-5t.....	2.4
10t.....	266AH-10t.....	2.4
20t.....	266AH-20t.....	4.2
30t.....	266AH-30t.....	8.3

Mounting Variation 1, Alloy Steel F266-1

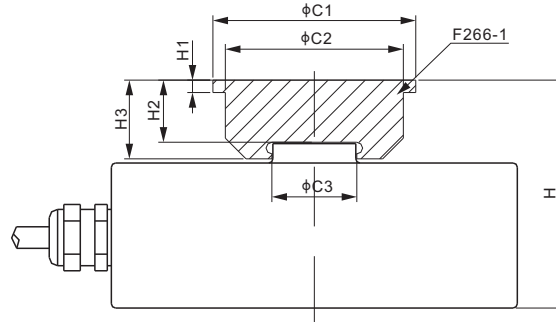

DIMENSIONS

PART NUMBER	LOAD CELL CAPACITY	DIMENSIONS							Weight (kg) Approx.
		C1	C2	C3	H	H1	H2	H3	
kg/mm									
F266-1B	25-2,000	41.0	35.0	13.8	35.1	3.0	13.1	16.0	0.12
F266-1C	3,000-5,000	49.0	43.0	20.5	55.1	3.0	15.1	19.0	0.20
F266-1C	10,000	49.0	43.0	20.5	60.1	3.0	15.1	19.0	0.20
F266-1D	20,000	60.0	54.0	21.0	70.1	3.0	20.1	24.0	0.41
F266-1D	30,000	60.0	54.0	20.5	93.1	3.0	20.1	24.0	0.41
lb/inches (conversion of above dimensions)									
F266-1B	55.1-4,409.2	1.61	1.38	0.54	1.38	0.12	0.52	0.63	0.12
F266-1C	6,613.9-11,023.1	1.93	1.69	0.81	2.17	0.12	0.59	0.75	0.20
F266-1C	22,046.2	1.93	1.69	0.81	2.37	0.12	0.59	0.75	0.20
F266-1D	44,092.5	2.36	2.13	0.83	2.76	0.12	0.79	0.95	0.41
F266-1D	66,138.7	2.36	2.13	0.81	3.67	0.12	0.79	0.95	0.41

Mounting Variation 2 F266-1 + F266-2 + ZPS

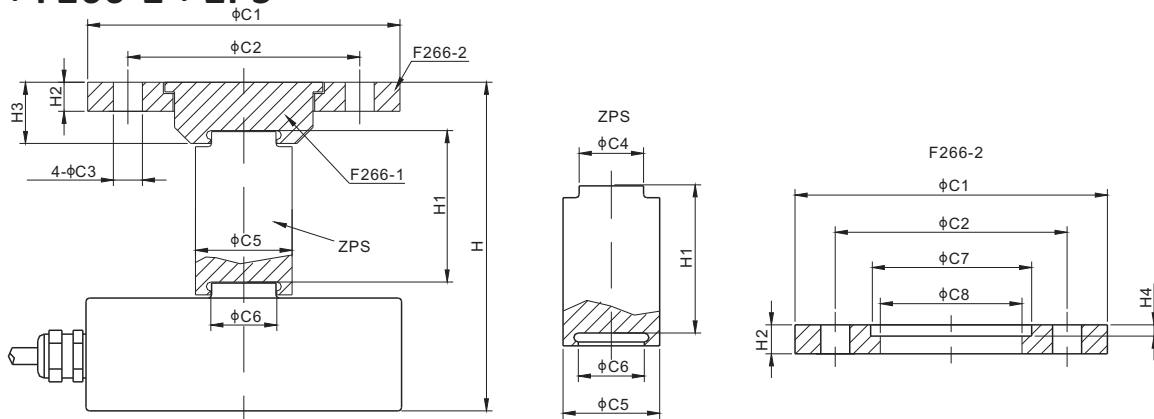

DIMENSIONS

LOAD CELL CAPACITY	C1	C2	C3	C4	C5	C6	C7	C8	H	H1	H2	H3	H4
kg/mm													
25-2,000	81.0	60.0	7.0	13.0	26.0	12.5	42.0	36.0	81.1	46.0	7.0	16.0	3.5
3,000-5,000	97.0	72.0	11.0	20.0	32.0	20.5	50.0	44.0	111.1	56.0	9.0	19.0	3.5
10,000	97.0	72.0	11.0	20.0	32.0	20.5	50.0	44.0	116.1	56.0	9.0	19.0	3.5
20,000	115.0	90.0	13.0	20.0	36.0	20.5	61.0	55.0	134.6	64.5	10.0	24.0	3.5
30,000	115.0	90.0	13.0	20.0	36.0	20.5	61.0	55.0	157.6	64.5	10.0	24.0	3.5
lb/inches (conversion of above dimensions)													
55.1-4,409.2	3.19	2.36	0.28	0.51	1.02	0.49	1.65	1.42	3.19	1.81	0.28	0.63	0.14
6,613.9-11,023.1	3.82	2.83	0.43	0.79	1.26	0.81	1.97	1.73	4.37	2.20	0.35	0.75	0.14
22,046.2	3.82	2.83	0.43	0.79	1.26	0.81	1.97	1.73	4.57	2.20	0.35	0.75	0.14
44,092.5	4.53	3.54	0.51	0.79	1.42	0.81	2.40	2.17	5.30	2.54	0.39	0.95	0.14
66,138.7	4.53	3.54	0.51	0.79	1.42	0.81	2.40	2.17	6.21	2.54	0.39	0.95	0.14

PART NUMBER

Load Cell Capacity	F266-1 Part No.	F266-2 Part No.	ZPS Part No.
25kg-2t.....	F266-1B.....	F266-2B.....	ZPS-B
3t; 5t; 10t.....	F266-1C.....	F266-2C.....	ZPS-C
20t; 30t.....	F266-1D.....	F266-2D.....	ZPS-D

Mounting Variation 3 F266-1 + F266-2 + FEB

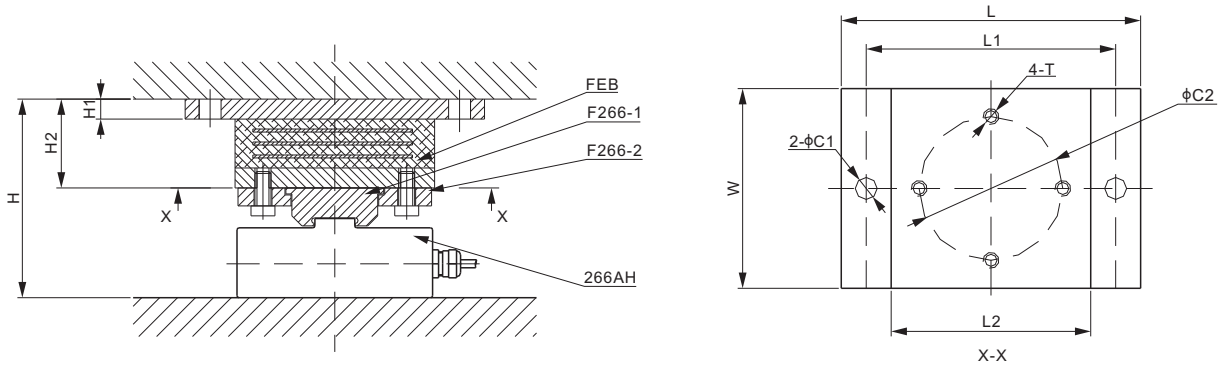

DIMENSIONS

LOAD CELL CAPACITY	C1	C2	H	H1	H2	L	L1	L2	W	T
kg/mm										
25-2,000	9.0	60.0	81.0	8.0	46.0	150.0	125.0	100.0	90.0	M8
3,000-5,000	11.0	72.0	99.6	10.0	44.5	180.0	150.0	120.0	120.0	M10
10,000	11.0	72.0	104.6	10.0	44.5	180.0	150.0	120.0	120.0	M10
20,000	13.0	90.0	120.1	12.0	50.0	270.0	240.0	200.0	200.0	M12
30,000	13.0	90.0	143.1	12.0	50.0	270.0	240.0	200.0	200.0	M12
lb/inches (conversion of above dimensions)										
55.1-4,409.2	0.35	2.36	3.19	0.31	1.81	5.91	4.93	3.94	3.55	M8
6,613.9-11,023.1	0.43	2.84	3.92	0.39	1.75	7.09	5.91	4.73	4.73	M10
22,046.2	0.43	2.84	4.12	0.39	1.75	7.09	5.91	4.73	4.73	M10
44,092.5	0.51	3.55	4.73	0.47	1.97	10.64	9.46	7.88	7.88	M12
66,138.7	0.51	3.55	5.64	0.47	1.97	10.64	9.46	7.88	7.88	M12

PART NUMBER

Load Cell Capacity	F266-1* Part No.	F266-2* Part No.
25kg-2t.....	F266-1B.....	F266-2B
3t; 5t; 10t.....	F266-1C.....	F266-2C
20t; 30t.....	F266-1D.....	F266-2D

PART NUMBER

Load Cell Capacity	FEB * Part No.	Weight (kg) Approx.
25kg-2t.....	FEB-B.....	2.3
3t; 5t; 10t.....	FEB-C.....	-
20t; 30t.....	FEB-D.....	-

* Neither F266-1 nor F266-2 includes the bolts, the bolts need to be ordered separately. FEB includes 4 bolts that match the hole size (T on the drawing).