

# ANYLOAD<sup>®</sup>

## 805HP

# HANDHELD INDICATOR

## MANUAL V13.4



<b>1</b>	<b>Electrical Performance</b> .....	<b>1</b>
<b>2</b>	<b>FEATURES</b> .....	<b>1</b>
<b>3</b>	<b>Display Icon List</b> .....	<b>2</b>
<b>4</b>	<b>Key List</b> .....	<b>2</b>
<b>5</b>	<b>Operation Mode</b> .....	<b>3</b>
<b>6</b>	<b>Start Up</b> .....	<b>3</b>
<b>7</b>	<b>Operations</b> .....	<b>5</b>
7.1	Normal Weighing Mode.....	5
7.1.1	ZERO SCALE.....	5
7.1.2	Acquire Tare Value.....	5
7.1.3	Remove Stored Tare Value.....	6
7.1.4	GROSS/NET MODE.....	6
7.1.5	Hold Value.....	6
7.1.6	Units.....	6
7.2	Peak Mode Operations.....	6
7.2.1	Peak/Normal Weighing Mode.....	6
7.2.2	Units.....	6
7.2.3	Remove Peak Mode Value.....	6
7.3	Cumulate Mode Operation.....	7
7.3.1	Save value of weight to memory.....	7
7.3.1	Show accumulated weight.....	7
7.3.2	Gross/Net Mode.....	7
7.3.3	Clear Cumulative value.....	7
<b>8</b>	<b>Menu setting</b> .....	<b>7</b>
8.1	Key Functions.....	7
8.2	Menu Operation.....	8
8.2.1	Enter Menu.....	8
8.2.2	Operation.....	8
8.3	Menu Structure and Parameter Descriptions.....	9
<b>9</b>	<b>Calibration</b> .....	<b>11</b>
<b>10</b>	<b>Digit Calibration</b> .....	<b>12</b>
<b>11</b>	<b>RS-232 Communication (wired version only)</b> .....	<b>13</b>
11.1	Serial communication baudrate.....	13

11.2 Data frame format.....	13
11.3 Communication mode.....	14
<b>12 Wireless configuration(wireless version only).....</b>	<b>14</b>
12.1 Set Up Wireless Address.....	14
12.2 Automatic Channel Search.....	15
12.3 Manual Switch Channels.....	15
12.4 Set Communication Power.....	15
<b>13.Overload Record.....</b>	<b>16</b>
13.1 Clear Overload Record.....	16
<b>14.Modify Password Menu.....</b>	<b>16</b>

## 1. Electrical Performance

<b>Non-linearity</b>	±0.001%F.S. Max
<b>Zero Temp. Drift</b>	±10nV/°C
<b>Max. Capacity Temp. Drift</b>	±3ppm/°C Max
<b>Max. Display Resolution</b>	1/10,000
<b>Min. Input Sensitivity</b>	0.3 μV/e
<b>Input signal range:</b>	0mV~±25mV
<b>Load cell Excitation Voltage</b>	1.22Vdc
<b>Power Supply</b>	3*AA 1.5V alkaline batteries
<b>Power Consumption</b>	Tested with 2200mAh alkaline batteries ≥500 hour with 380Ω load cell in idle mode ≥250 hour with 380Ω load cell in weighing mode ≥1000 hour with 1000Ω load cell in idle mode ≥350 hour with 1000Ω load cell in weighing mode
<b>Operation Temperature</b>	-20°C ~ +70°C

## 2. Features

<b>Display</b>	6-digit panoramic FSTN LCD with LED back light
<b>Sampling Frequency</b>	4.17/6.25/8.33/10/12.5/16.7/33.2/50/62/123Hz are user-selectable.
<b>Display content</b>	Display can show a positive or negative number, and decimal point can be selected to any position.
<b>Interface</b>	RS-232C
<b>Overload protection</b>	User-selectable overload warning value and alarm value. Overload warning and alarm can be enabled or disabled Overload alarm peak records can be reviewed
<b>Functions</b>	2 set-points calibration, Zero scale, Tare, Low battery warning, Peak-hold.
<b>Units</b>	kg/lb/t/g/oz/klb/N/kN/ are user-selectable units. Measurements units can be enabled independently and switched. The default unit can be selected.
<b>Power-down storage</b>	Date can be saved after power-off. Date can also be saved after removing batteries.
<b>power-saving</b>	If inactive for a period of time set by user, the auto power-saving mode will activate. If inactive for a period of time set by user, the auto power-off mode will activate.

### 3. Display Icon List

Icon	Meaning
	Battery Power .
	Peak hold mode
<b>M+</b>	Weight saved to memory
	Tare value acquired
	Gross weight
	Cumulate Mode
	Zero Scale
	Wireless communication is normal
	Weight surpass "overload warning value "signal
	Stability signal
...	There is a hidden figure which will be shown on the following page

### 4. Key List

		【SWITCH】	【ZERO】 ↑	【TARE】 ↓	【UNITS】 ←	【HOLD】 →	【CUMULATE】 ↙
<b>Normal weighing mode</b>	short press		zero scale	tare/ untare	units exchange	holding/ cancel	accumulate
	long press	turn off				go to Peak mode	go to Cumulate mode
<b>Peak mode</b>	short press					clear peak mode value	
	long press					return normal weighing mode	
<b>Cumulate mode</b>	short press			gross/net cumulative value	show the highest five digit	show the lowest five digit	add weight to memory
	long press	turn off	clear cumulative value				return normal weighing mode
<b>Menu</b>	short press		↑	↓	←	→	enter
	long press						add/delete decimal point

## 5. Operation Mode

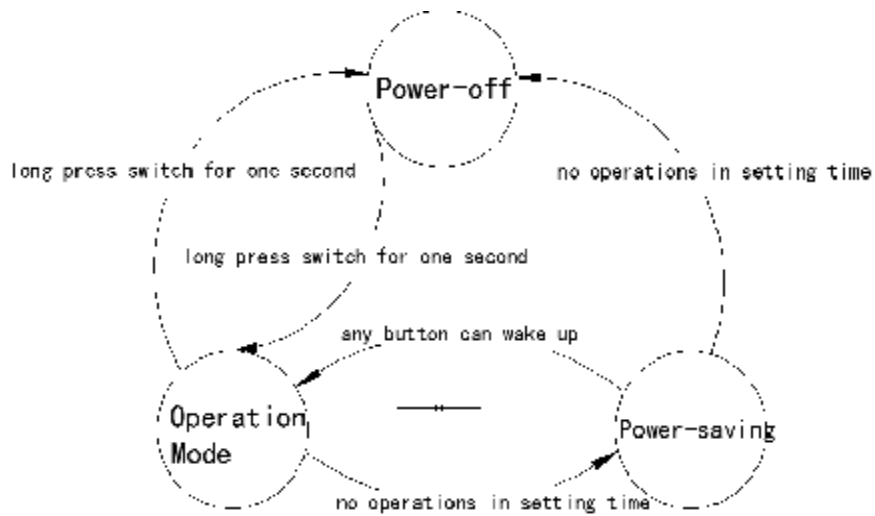

<b>Operation mode</b>	manual
<b>Power-off</b>	When the indicator is turned off, date will be saved in non-volatile memory.
<b>Operation mode</b>	When the indicator enter wake-up mode, all functions are enable, and the power run dynamically.
<b>Power-saving</b>	LCD is on, but backlight is off. RS-232 circuit shut down.

## 6. Start Up

Connect load cell (communication & printer) to 805HP according to the following connection diagram.

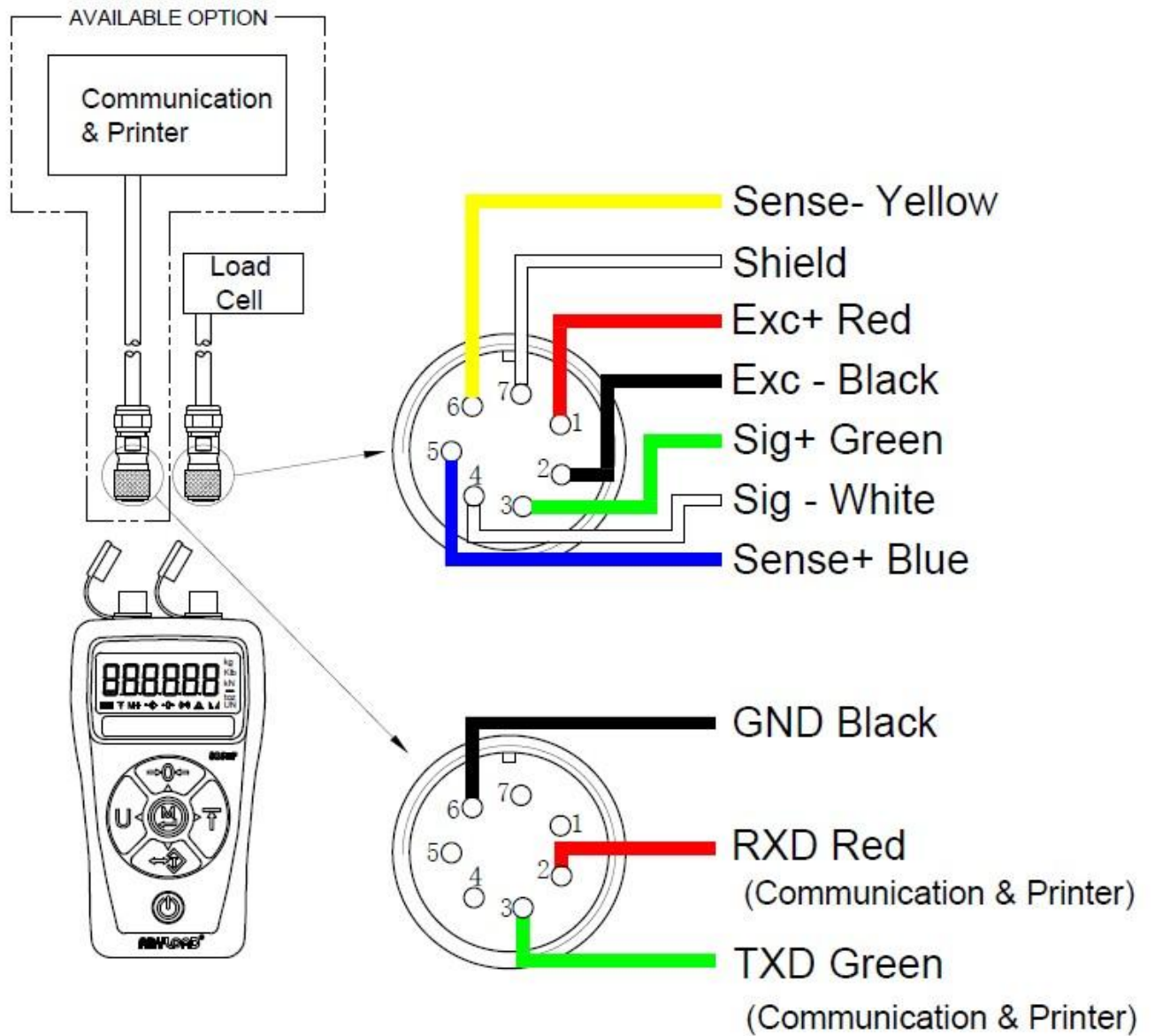

3D schematic diagram.

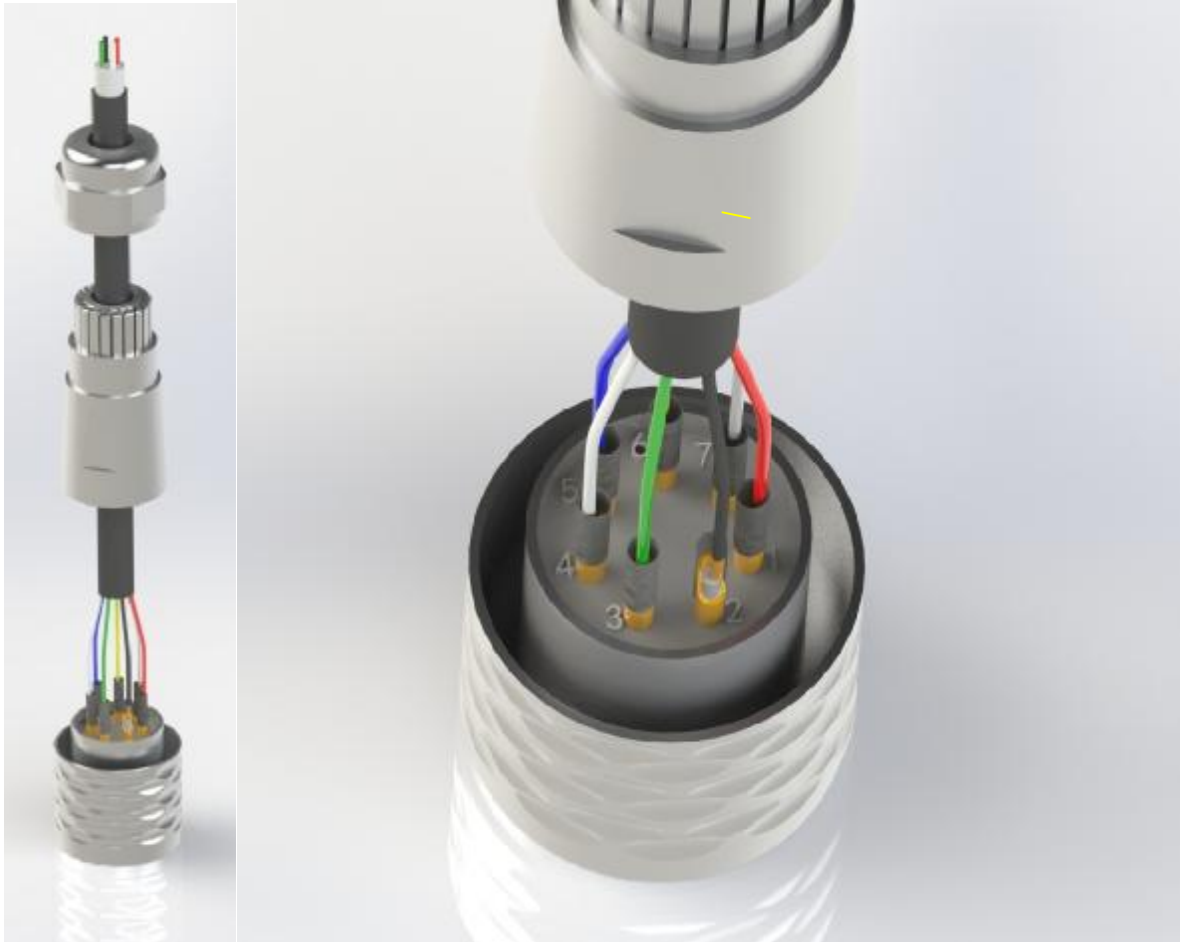

Press **【SWITCH】** for one second, indicator is turned on. After indicator cycles through from 0 to 9, the indicator will enter Normal Weighing mode.

## 7. Operations

Indicator is in Normal Weighing mode when the switch is turned on. It can be set to Normal Weighing mode and Peak mode.

### 7.1 Normal Weighing Mode

When indicator is set to the Normal Weighing mode,  $\overline{\uparrow}$  (Peak mark) does not appear.

Basic operations in Normal Weighing mode:

#### 7.1.1 Zero Scale

When in the Gross weight mode,  $\leftrightarrow$  (Tare mark) does not appear and  $\square$  (Gross weight) appears. Remove the load from the scale and wait until  $\blacktriangle$  (Stable mark) appears. Press  $\uparrow$  **【ZERO】**, and  $\rightarrow 0 \leftarrow$  (Zero mark) appears. Zero Scale setting completed.

#### 7.1.2 Acquire Tare Value

When no Tare is stored ( $\leftrightarrow$  [Tare mark] does not appear), place the load on the scale and wait until  $\blacktriangle$  (Stable mark) appears. Press  $\downarrow$  **【TARE】**, Tare weight is stored. Display is in Net weight when  $\leftrightarrow$  (Tare mark) is displayed,  $\square$  (Gross weight mark) disappears.

## 7.1.3 Remove Stored Tare Value

When indicator has stored tare weight value other than 0 ( $\leftrightarrow$  [Tare mark] appears), press  $\downarrow$  **【Tare】** to remove the stored tare weight value. Display is in Gross weight mode when  $\leftrightarrow$  (Tare mark) is not displayed.

## 7.1.4 Gross/Net Mode

When tare weight is stored (indicator has stored tare weight value other than 0), press  $\downarrow$  **【TARE】** to change from net weight to gross weight or vice versa.

$\square$  (Gross Weight mark) appears when in gross weight mode.

$\square$  (Gross Weight mark) disappears when in net weight mode.

## 7.1.5 Hold Value

Press  $\rightarrow$  **【HOLD】** , displayed weight will flash and will not change

Press  $\rightarrow$  **【HOLD】** again, displayed weight will stop flashing and value can now change.

## 7.1.6 Units

Press  $\leftarrow$  **【UNITS】** to switch between the default unit and the unit set by user. Display shows the current choice of unit.

## 7.2 Peak Mode Operation

To activate Peak Weighing Mode, long press  $\rightarrow$  **【HOLD】** and  $\overline{\uparrow}$  (Peak mark) appears.

### 7.2.1 Peak/Normal Weighing Mode

When  $\overline{\uparrow}$  (Peak mark) appears, peak mode is activated. Display always shows the maximum value of load which has been applied to the load cell. When the load is removed, display still shows the peak load. When  $\overline{\uparrow}$  (Peak mark) disappears, peak mode is deactivated. Value shown on display changes according to the load applied to the load cell. Long press  $\rightarrow$  **【HOLD】** can change indicator from Peak mode to Normal Weighing mode, or vice versa.

### 7.2.2 Units

It's the same as the operations in Normal Weighing mode

### 7.2.3 Remove Peak Mode Value

When Peak mode is on ( $\overline{\uparrow}$  (Peak mark] appears), remove the load and short press  $\rightarrow$  **【HOLD】** .Peak mode value is removed, and indicator starts another Peak mode operation.

## 7.3 Cumulate Mode Operations

		【SWITCH】	【ZERO】 ↑	【TARE】 ↓	【UNITS】 ←	【HOLD】 →	【CUMULATE】 ✓
<b>Cumulate mode</b>	short press			gross/net cumulative value	show the highest five digit	show the lowest five digit	add weight to memory
	long press	turn off	clear cumulative value				return Normal weighing mode

### 7.3.1 Save value of weight to memory

Short press ✓ 【CUMULATE】 , display will flash 'total'. M+(Memory mark) will appear. Weight is now saved to memory.

### 7.3.2 Show accumulated weight

Long press ✓ 【CUMULATE】 , indicator changes to Cumulate mode from weighing mode or peak mode, or vice versa.

When indicator is in Cumulate mode, display shows the accumulated total gross weight value.

### 7.3.3 Gross/Net Mode

Press ↓ 【TARE】 , indicator changes from Gross mode to Net mode, or vice versa.

Display shows total gross weight value while  (Gross Weight mark) appears.

Display shows total net weight value while  (Gross Weight mark) disappears.

### 7.3.4 Clear Cumulative Value

Long press ↑ 【ZERO】 , total gross weight value and total net weight value will be cleared.

## 8. Menu Setting

### 8.1 Key Functions

	【ZERO】	【TARE】	【UNITS】	【HOLD】	【CUMULATE】
<b>short press</b>	↑	↓	←	→	✓
<b>long press</b>					add/delete decimal point

## 8.2 Menu operations

### 8.2.1 Enter the menu

Press ↑,↓ at the same time for 1 second, the indicator will show 

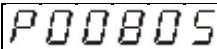
asking for the password. The password is 

Press directional ←,→,↑,↓ to input the passwords, and press ✓ to enter the configuration menu.

If invalid password is entered, display will re-enter weighing mode.

### 8.2.2 Operation

The menu structure and keys operation are shown in the following flow diagram.

# ANYLOAD

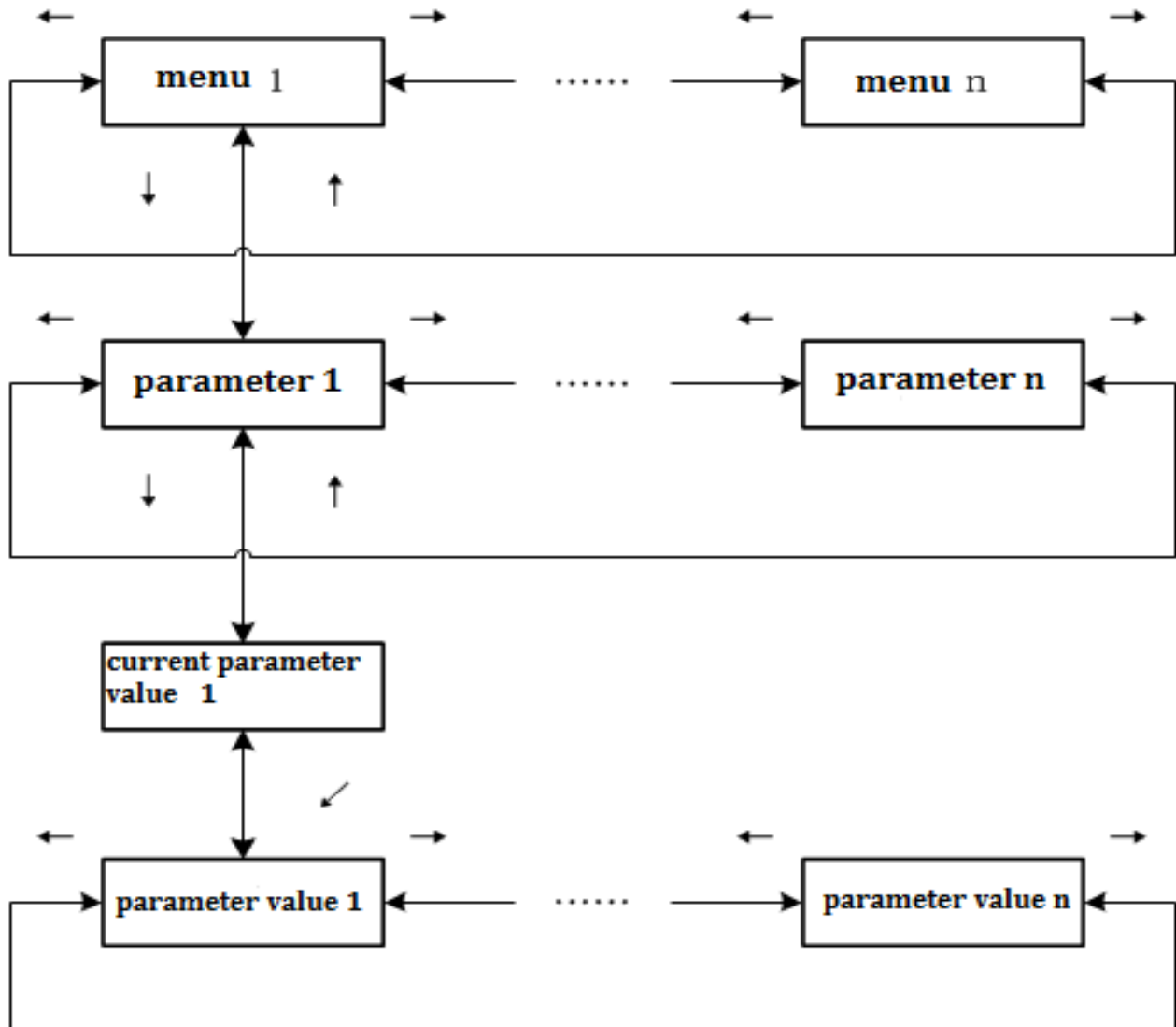

There are 4 directional keys ←,→,↑,↓ to be used for the operation. ←,→ are used for horizontal movement in the same level menu and parameters. ↑,↓ are used for moving up and down through different level menus.

Use ←,→ to choose a parameter in a menu and use ↓ to move to the next level menu or parameter.

When moving into a parameter of a menu, the indicator shows the previous choice.

If you want to change the parameter values, use ↙ to move into the parameter change status. When the parameter of a menu is a fixed value, use ←,→ to move horizontally. Use ↙ to store the selected parameter and to return to the last menu.

When a parameter value of a menu is editable, directional keys ←,→ are used to edit the digit selected, directional keys ↑,↓ are used to increase and decrease the value of the selected digit. Press ↙ to save the input values and exit.

## 8.3 Menu Structure and Parameter Descriptions

In the actual menu structure, the selected menu item is displayed horizontally.

The parameter value with the symbol ( ) is the default value of system reset.

Menu	Display	Parameter	Parameter Value
USER	BEEP	buzzer switch	[on]/off
	LITE En	background light switch	[on]/off
	LIGHT	Background light turn off time/ s	dis/1/2/3/5/[10]/15/20/30/60
	A OFF	Auto off time/min	[dis]/1/2/3/5/10/15/20/30/60
	kg	Unit kg	[on]/off
	t	Unit t	on/[off]
	g	Unit g	on/[off]
	lb	Unit lb	on/[off]
	oz	Unit oz	on/[off]
	klb	Unit klb	on/[off]
	N	Unit N	on/[off]
	kN	Unit kN	on/[off]
	UN	Unit UN	on/[off]
	UN uAL	User's unit	Any Number
DFE U	Default unit	[kg]/lb/t/g/oz/klb/N/kN/user's unit	
OVER	PRE	Overload Warning	[on]/off
	PRE u	Overload Warning value	Any Number (lower than Overload Alarm value)
	over	Overload Alarm	[on]/off
	over u	Overload Alarm value	Any Number (higher than Overload Warning value)
	HI OA	Historical maximum overload value	(read only)
CONFIG	InCrE	Division value	0.001/0.002/0.005/0.01/0.02/0.05/0.1/0.2/0.5/0.1/0.2/0.5/[1]/2/5/10/20/50
	LAP	Rated Weighing	Any number
	rHEE	Sampling speed/Hz	4.17/6.25/8.33/[10]/12.5/

# ANYLOAD

			16.7/33.2/50/62/123
	StE b t	Stability Judgement times/s	[0.5]/1/2
	StE b r	Stability judgement range/d	0.1/0.2/0.3/0.4/[0.5]/0.75/1/1.25/1.5/1.75/2/2.5/3/3.5/4/5
	G	Acceleration of gravity value	Any number
LAL	zE r o	Zero A/D count	(read only)
	L o A d	Calibrated weight	Any number
	LAL	Calibrated point A/D count	(read only)
	t A r t	Zero offset value	(read only)
dLAL	zE r o	Zero A/D count	Any number
	L o A d	Calibrated weight	Any number
	LAL	Calibrated A/D count	Any number
oU t (For wired version only)	L o n	Serial communication	on/[off]
	b A U d	Baud rate/bps	[1200]/2400/4800/9600
	b i t	Output DB	[8n1]/8o1/8E1
	t Y P E	Communication mode	[contin]/reque
r A d i o (For wireless version only)	r F r A t	Wireless radio frequency	[2Hz]/3Hz/4Hz/5Hz
	A d d r	Wireless address	0~255 Any number
	S E E P	Automatic channel search	
	b A n d	Manual switching channel	1~16
	G A I n	Wireless gain	1~8
S Y S	v E r	Software version	(read only)
	r E S E t	System parameter reset	
	m o d e	Software Mode	[None]/OIML/NTEP/Canada

## 9. Calibration

Before calibrating, please make sure the local Gravity is in line with the Gravity stored on the indicator, otherwise, modify it according to the local Gravity value.

The calibration consists of the following steps:

- Zero A/D count
- Weight Calibration.
- Calibrated point A/D count
- Zero offset value (Zero offset can be re-corrected when using hooks or

chains to hang the test weights.)

The following describes calibration procedure for each of the calibration methods:

1) Enter the configuration menu, the indicator shows `U.S.E.r`, Remove all loads.

If hooks or chains are used to hang the test weights, load the hooks or chains.

2) Press  $\rightarrow$  until the indicator shows `CAL`. Press  $\checkmark$  to move into zero A/D count.

3) The indicator shows `E.E.r.o`, press  $\checkmark$  to zero calibration. The indicator shows the A/D count for the zero calibration, e.g. `505 147`. Press  $\checkmark$  again to save the value and go to the next menu.

4) The indicator shows `LoAd`. Load test weights, press  $\checkmark$ . The indicator shows the test weight value, e.g. `000500`. Press  $\leftarrow, \rightarrow, \uparrow, \downarrow$  to input the test weight value. Press  $\checkmark$  to save the value and go to the next menu.

5) The indicator shows `CAL`. Press  $\checkmark$  to calibrate span. The A/D count for the span calibration is shown, e.g. `885920`. Press  $\checkmark$  again to save the calibration value and go to the next menu.

6) When the indicator shows `E.A.r.E`, there are 2 options:

6.1) If no chains or hooks are used to hang the test weights during calibration, remove the test weight and press the start key to finish the calibration and return to weighing mode.

6.2) If hooks or chains are used during the calibration, remove these and the test

weights. With all weight removed, press ✓ to re-zero (this function can be used to remove the tare weight deviation if the hooks or chains are used to hang the test weights). The indicator shows the current A/D count, e.g. `500 187`. Press ✓ again to finish the calibration and return to weighing mode.

**Suggestion:** When calibration is finished, record the A/D count of zero and span calibration, so that you may re-calibrate your indicator simply by entering the recorded A/D count of zero and span calibration.

## 10. Digit Calibration

The digit calibration consists of the following steps:

- zero A/D count
- weight Calibration.
- Calibrated point A/D count

The following describes calibration procedure for each of the calibration methods:

- 1) Enter the configuration menu, the indicator shows `USER`.
- 2) Press → until the indicator shows `dCAL`. Press ✓ to move into zero A/D count.
- 3) The indicator shows `Zero`. Press ✓ and the indicator will show `0000`  
`00`. Press ←,→,↑,↓ to input the new zero A/D count. Press ✓ again to save and go to the next menu.
- 4) The indicator shows `Load`. Press ✓ and the indicator will show `0000`  
`00`. Press ←,→,↑,↓ to input the new test weight value. Press ✓ to save and go to the next menu.
- 5) The indicator shows `CAL`. Press ✓ and the indicator will show `0000`  
`00`. Press ←,→,↑,↓ to input the new Span A/D count. Press ✓ again to save and finish the digit calibration.

## 11. RS-232 Communication (wired version only)

The indicator has a standard RS-232 serial output interface to connect to large screen monitors, computers or other peripherals. Its effective connection distance is 15 meters and any more than this distance will lead to a high error rate.

- To turn on/off serial communication, enter the configuration menu and press → until the indicator shows `o u t`. Press ↓ to enter the submenu `[ o n` and select on/off with ←,→. Press ✓ to confirm selection.

## 11.1 Serial communication baud rate

Serial communication baud rates 1200bps, 2400bps, 4800bps, 9600bps are available.

The baud rate is set in the submenu `b A U D` using ←,→. Press ✓ to confirm selection.

## 11.2 Data frame format

Data frame format is set in `b i t` submenu. Press ↓ to enter the submenu and use the ←,→ to select your desired format. Press ✓ to confirm selection.

Serial output format can be configured as 8N1 / 8O1 / 8E1.

8N1 means 1 start bit, 8 data bits, 1 stop bit, no parity.

8O1 means 1 start bit, 8 data bits, 1 stop bit, odd parity.

8E1 means 1 start bit, 8 data bits, 1 stop bit, even parity.

Indicator outputs data in the form of byte frame. Every byte frame is constituted by eight bytes of data, and all the bytes are ASCII.

|=|D0|D1|D2|D3|D4|D5|D7|

Each frame begins with '=' (0x3D).

Each frame contains seven data bytes, including decimal point '.' (0x2E).MSB first, and the LSB follows. If there is a negative sign '-' (0x2D), then it will be transmitted first.

For example, transmit 70.15, that is transmitting |=|||7|0|.|1|5|

For example, transmit -32.5, that is transmitting |=|||-|3|2|.|5|.

## 11.3 Communication mode

Two communication modes can be selected in `t Y P E` submenu. Press ↓ to enter the submenu and use the ←,→, to select your desired communication mode. Press ✓ to confirm selection.

When the parameter is configured to contin, indicator transmits data in the form of one frame after the other .

When the parameter is configured to reque, if and only if the indicator receives ASCII code '@' character, it will send a data frame.

## 12. Wireless Configuration (wireless version only)

The indicator will be set to match the corresponding wireless transceiver before it leaves the factory. If you need to change the indicator or wireless transceiver, or because of radio frequency interference, you can configure the communication parameters to re-obtain high-quality communications.

### 12.1 Set up a wireless address

The wireless transceiver has its own independent and fixed communication address. Address code is 0~255. When the address code of the indicator is consistent with the address of the wireless transceiver, wireless communication can work normally. Therefore, make sure their wireless communication address is consistent.

Check *Addr* parameter values of the *rAdi o* menu and make any necessary changes to match the address code of the wireless transceiver.

### 12.2 Automatic Channel Search

After completing the wireless address set up, execute command *SEEP*. Indicator will automatically search the wireless transceiver channels from 1 to 16.

If the channel search is successful, indicator will display *PASS*.

If the channel search fails, indicator displays *FAIL*. Check if the wireless transceiver power supply is normal, if the communication distance is too far, and if radio frequency interference exists.

### 12.3 Manually switch channels

When multiple sets of wireless systems are needed in the same location, wireless

systems of the same channel may crosstalk. To avoid this, you need to switch channels manually. Using different channels to distinguish between different wireless systems will ensure high quality wireless communications.

To manually change channels, execute command `bAnd` of the `rAdIo` menu.

Press ←、→ key to choose the designated channel number (1 to 16), and press ✓ key to execute the handover command.

If the channel matches successfully, indicator displays `PASS`.

If the channel fails to match, indicator displays `FAIL`. Switching command is repeatable until channel match is successful.

## 12.4 Set communication power

Wireless system communication quality varies according to the transceiver distance. High-power communications can effectively increase the communication distance, but at the expense of increased power consumption.

To set communication power, execute command `GAIn` of the `rAdIo` menu.

Press ←、→ key to and select the power level (1 to 8), press ✓ key to perform the set command.

When the power settings are successful, indicator displays `PASS`.

When the power settings fails, indicator displays `FAIL`. Switching command can be executed repeatedly until switched successfully.

## 13.Overload record

This indicator records the real time overload situation.

When loading weight exceeds the overload alarm set value, the background light flashes (if background light is enabled), the panel shows  (warning), the display flashes, and shows the error message `o u E r`.

When loading weight exceeds the overload alarm set value, the background light flashes (if background light is enabled), the panel shows  (warning signs), the

display flashes, shows the error message *ALARM*, and the buzzer warns intermittently.

If, overload weight exceeds the historical maximum overload weight, the historical maximum overload weight will be updated.

## 13.1 Clear Overload Record

Press the ↑, ↓ key, and hold for 1 second, indicator pops up the password screen

*P00000*.

Press the arrow keys ←, →, ↑, ↓ Enter the password 80500, then press ✓ key. The screen displays *OU CLR* and will clear the overload cumulative value.

## 14. Modify menu password

Press the ↑, ↓ key, and hold for 1 second, indicator pops up the password screen

*P00000*.

Press the arrow keys ←, →, ↑, ↓ Enter the password 08050, then press ✓ key

Display shows the password menu *Pword* (PASSWORD). Press ↓ to enter.

The first parameter is the user's password *USER P* (USER P), press ↓ to enter,

display the current password, for example *05432* !. Note that the password is

effective only within five- digital, one hundred thousand digits will be discarded. Press

✓ key to start modification, press the arrow keys ←, →, ↑, ↓ enter the new password,

press ✓ key again to save, press ↑ key to return to the previous menu.

**ANYLOAD<sup>®</sup>**

**<http://www.anyload.com>**

North America Toll Free: 1-855-ANYLOAD (269 5623)

Fax: +1 866 612 9088

Email: [info@anyload.com](mailto:info@anyload.com)