

# ANYLOAD<sup>®</sup>

## 805HP

Handheld Digital Weight Indicator

User's Manual (v1703)



**Anyload Transducer Co. Ltd**

Website: [www.anyload.com](http://www.anyload.com)

Email: [info@anyload.com](mailto:info@anyload.com)

**TABLE OF CONTENTS**

1. Introductions and Features	2
2. Safety Recommendations	2
3. Display Icon List	3
4. Keys	4
5. Work Mode	5
6. Start Up and adjust	6
6.1 Battery Installation	6
6.2 Indicator Dimensions	7
6.3 Connection Diagrams	8
7. Weighing Modes	7
7.1 Normal Weighing Mode	7
7.2 Gross/Net Mode	8
7.3 Peak Mode	10
7.4 Cumulate Mode	11
7.5 Calibration Mode	12
8. Configurations and Menu Operations	13
8.1 Menu Operations	13
8.2 Overload	17
8.3 Modify Password	18
9. Communication	19
9.1 RS232 Communication	19
9.2 Wireless Communication	20
10. Calibration and Parameter Settings	21
10.1 Standard Value Calibration	22
10.2 Digit Calibration	24
11. Troubleshooting Guides	26
12. Technical Specifications	27
13. Appendices	29

## 1. Introductions and Features

Thank you for choosing Anyload 805HP Handheld Digital Weight Indicator. The 805HP hand held digital weight indicator is a general purpose and durable indicator that provides high accuracy, reliability and multiple functions. The 805HP can drive up to eight 350Ω or thirty two 1000Ω load cells. With an IP65 ABS wash down enclosure, the 805HP digital weighing indicator is ideal for use in Transportation, Entertainment, Aerospace, Military, Food and Agricultural industry.

### Key Features include:

- Exceptionally long battery life ( 3-AA batteries )
- LED backlight and panoramic FSTN LCD view angle
- Material: ABS
- IP Rating: IP65
- LCD 6-digit display with LED backlight
- Non-volatile memory for reliable date saving
- Units of Measurement: kg, g, t, lb, Klb, N, kN, oz, user-defined unit
- Configurable 21 set-points for precaution and warning
- User-selectable display interval
- Overloading recording
- 10 user-selectable analog-to-digital converting frequency
- Weight calibration and digital calibration
- User-selectable auto power-off and power-saving timing
- Functions: Auto-Zero Tracking, Auto-Zero, Manual-Zero, Hold, Peak-Hold, TARE

This manual provides installation, operation and configuration information of 805HP indicator. It is recommended to go through the manual in details before installing, operating or configuring the indicator.

## 2. Safety Recommendations

Important instructions which involve safety are highlighted with the appropriate mark:





When it is required to work inside the indicator enclosure for some procedures described, the work can only be performed by qualified technical personnel.

### 3. Display Icon List

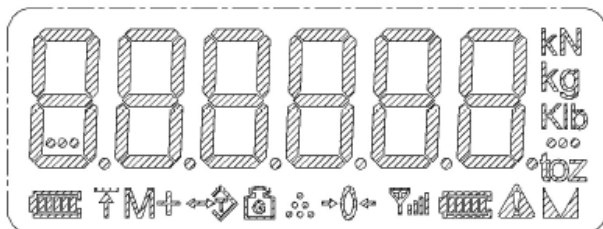





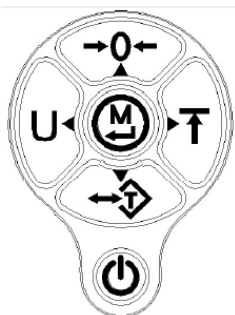

Icon	Meaning
	805HP Battery Power indicator
	Peak hold mode
	Weights saved to memory
	Tare value acquired
	Gross weight mode
	Cumulate Mode
	Scale is zeroed
	Wireless signal strength
	Load cell battery power indicator
	Weight exceeded the maximum capacity “overload warning value “signal
	Signal stability
	There are hidden figures which can be shown on the following page

Refer to Section 13 (Appendices) for detailed on alphanumeric symbols.  
 ( Appendix 13.1-Seven Segment digital display alphanumeric table )







## 4. Keys

### 4.1 Key List



Key	Functions
	Power Button
	Tare; Down key
	Unit; Left key
	Zero; Up key; Return key
	Peak; Right key
	Cumulate; Enter key

## 4.2 Key Instructions for all weighing modes

Buttons	Press Duration	Modes		
		Normal	Peak	Cumulate
 <b>【SWITCH】</b>	Short press (0.5 sec)			
	Long press (2 sec)	Turn Off	Turn Off	Turn Off
 <b>【CUMULATE】</b>	Short press (0.5 sec)	Accumulate (Add weight to memory)		
	Long press (2 sec)	Show cumulative value	Show cumulative value	Exit cumulate mode
 <b>【ZERO】</b>	Short press (0.5 sec)	Zero the scale		
	Long press (2 sec)			Clear Cumulative value
 <b>【HOLD】</b>	Short press (0.5 sec)	Holding/ Cancel	Clear Peak Value	
	Long press (2 sec)	Go to Peak Mode	Return to Normal Weighing Mode	
 <b>【TARE】</b>	Short press (0.5 sec)	Tare/Untare		
	Long press (2 sec)	Gross/Net Weight		Gross/Net Weight
 <b>【UNITS】</b>	Short press (0.5 sec)	Switch units	Switch units	
	Long press (2 sec)			

## 5. Work Modes

### 5.1 Overview

Operation mode	Function
Power-off	When the indicator is turned off, data will be saved in non-volatile memory.
Operation mode	When the indicator enters wake-up mode, all functions are enabled and the power run dynamically.
Power-saving	When LCD is on and backlight is off, the RS-232 circuit is off.

### 5.2 Operation Mode Switching Diagram

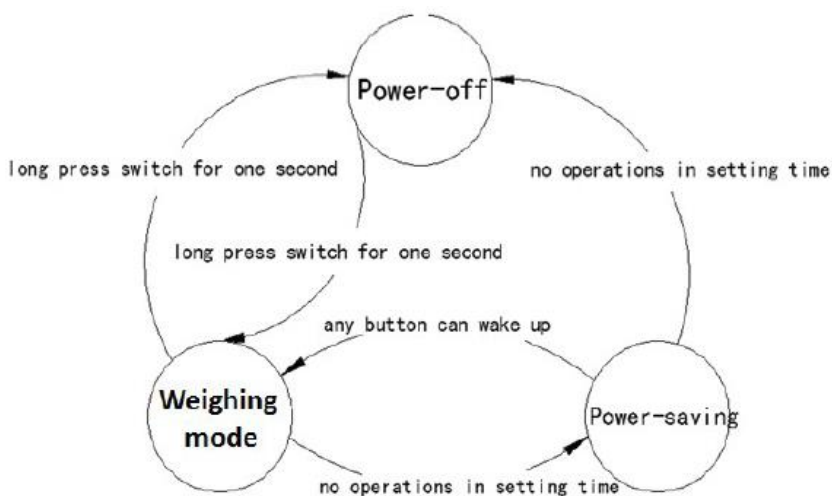



## 6. Start Up and Adjust

### 6.1 Battery Installation

Open the battery compartment cover and install the battery as shown in figure below.

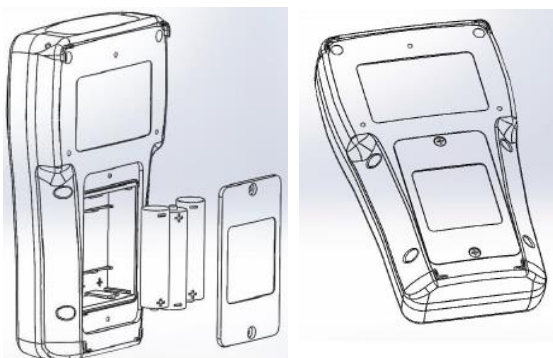
*Note: Remove the battery when indicator will not be used for a long period.*



- **Start up** - After installing the battery, long press the on/off button  for 2-3 seconds then release it. The indicator will beep and the screen shows initialization until reached to indicator weighing system.
- **Power off:** Long press on/off button  for 2-3 seconds then release it. The screen shows OFF, the indicator is turning off.



**6.2 Indicator Dimensions**

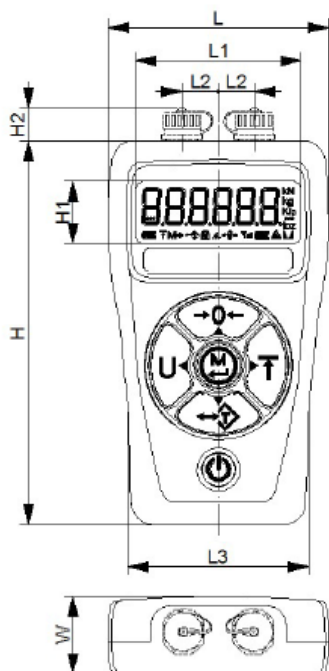

(Unit)	H	H1	H2	L	L1	L2	L3	W
Inches	6.7	1.1	0.5	3.9	2.8	0.6	3.2	1.3
mm	170	27	13	98	72	15	80	34

## 6.3 Connection Diagrams

### 6.3.1 805HP Wired Model

Connect load cell (communication & printer) to 805HP according to the following connection diagram:

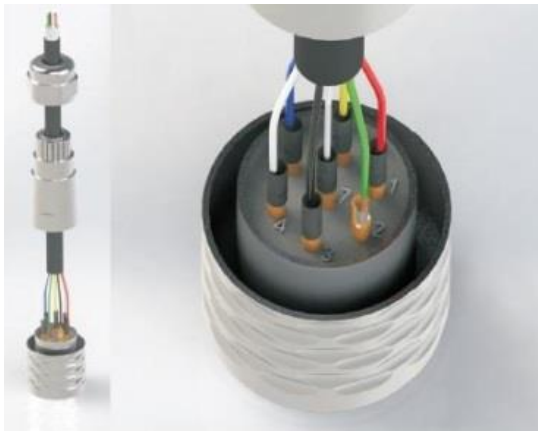
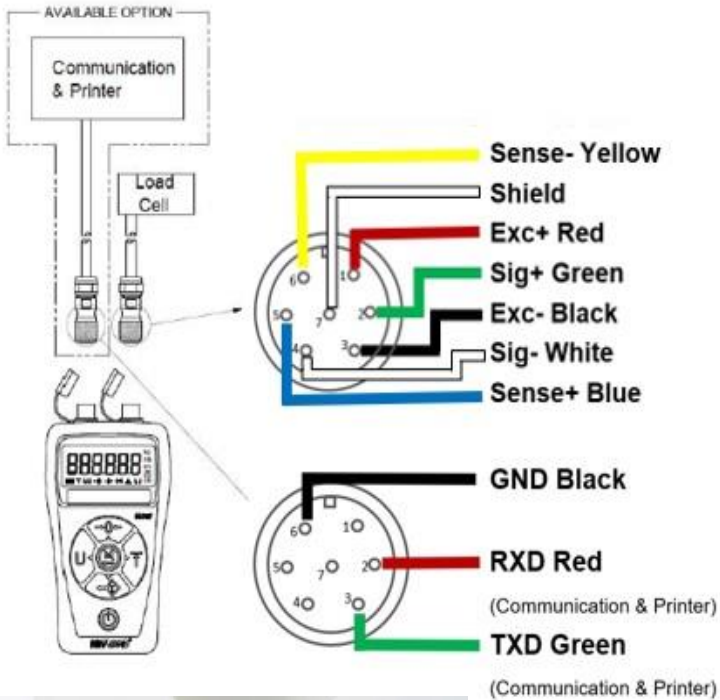

### 6.3.2 805HP Wireless Model

The indicator is set to match the corresponding wireless transceiver of a wireless scale. Usually 805HP-WL wireless model is paired with Anyload 110RH-WL TENS LINK scale or 110ES-WL Salt Waterproof scale. If you need to change the indicator's wireless configurations due to radio frequency interference, you can configure the communication parameters with the following steps in Section 9.2- Wireless Communication of this manual.

## 7. Weighing Modes

The indicator has three (3) weighing modes namely, Normal Mode, Cumulate Mode and Peak Mode. The indicator will automatically set to Normal Mode upon starting it up. Usually it will be zeroed automatically when it is within the 20% of the full range zero range.

### 7.1 Normal Weighing Mode

Normal Mode is the most common application in weighing mode which is enabled by default in the indicator. This mode meets most of the weighing requirements. The Normal Mode is the real-time feedback and the accurate weighing.

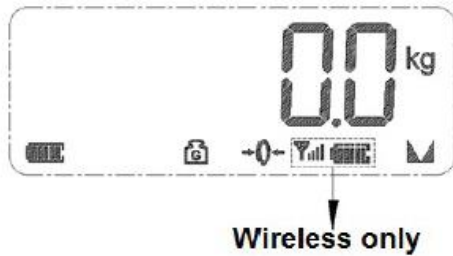

When indicator is set to the Normal Weighing mode, **T** (Peak mark) will not appear in the display

#### 7.1.1 Basic Operations in Normal Weighing Mode

##### I. Zero the Scale

Remove the loads from the scale and wait until **M** [Stable mark] appears. The scale should not in Tare mode and **G** [Gross weight mark] is on. Press **↑** **【ZERO】** and **-0-** (Zero mark) appears. Zero the scale setting is completed.

## II. Acquire Tare Value

When no Tare is stored [Tare mark] does not appear. Place the load on the scale and wait until (Stable mark) appears. Press ↓ 【TARE】 , the tare weight will be stored. The display is in Net weight when (Tare mark) is displayed and (Gross weight mark) is off.

## III. Remove Stored Tare Value

When indicator has stored tare weight value other than 0, [Tare mark] appears. Press ↓ 【Tare】 to remove the stored tare weight value. The display is in Gross weight mode when (Tare mark) is off.

### 7.2 Gross/Net Mode

When tare weight is stored (indicator has stored tare weight value other than 0), press ↓ 【TARE】 to change from net weight to gross weight or vice versa.

(Gross Weight mark) appears if it is in gross weight mode.

(Gross Weight mark) disappears if it is in net weight mode.

### 7.3 Peak Mode

Peak Mode is a weighing mode which indicator shows and hold the peak weight value In the process of weighing. This mode is typically applied to a system when recording the peak reading of weights.



To activate Peak Weighing Mode, long press → 【HOLD】 and (Peak mark) appears

## I. Peak/Normal Weighing Mode

When (Peak mark) appears, peak mode is activated. The display always shows the maximum value of load which has been applied to the load cell. When the load is removed, the display still shows the peak load. When (Peak mark) disappears, peak mode is deactivated. The value shown on display changes according to the load applied to the load cell. Long press the → **【HOLD】** can change the indicator from Peak mode to Normal Weighing mode, or vice versa.

## II. Remove Peak Mode Value

When Peak mode is on, [Peak mark] appears. Remove the load and short press the → **【HOLD】** button. The Peak mode value is removed and indicator will start another Peak mode operation.

## 7.4 Cumulate Mode

Cumulate Mode is a special function added under the normal weighing mode. In this mode, the indicator saves weight readings into memory and previews the accumulated weight value for all saved weight readings. Both real-time feedback weighing data can also check the cumulative weighing value.



### I. How to cumulate weighing values?

Only and during in the normal weighing mode and if the indicator reading is more than zero or when the weight has been tared, short press  to record the current weight data. Indicator shows as follows:



The recently saved weight readings will be displayed in the screen after 1 second. The **M+** sign appears in the lower left corner of the screen. This means that weight data are recorded and be accumulated.

## II. How to view the cumulative value?

Long press the  and it shows the cumulative value. The  sign appears in the middle of the screen. Indicator shows as follows:



Long press , indicator changes from Cumulate to Normal weighing mode or peak mode, or vice versa.

## III. Gross/Net Mode

Press  **【TARE】**, the indicator changes from Gross mode to Net mode, or vice versa.

Display shows total gross weight value - (Gross Weight mark) is on.

Display shows total net weight value - (Gross Weight mark) is off.

## IV. Clear Cumulative Value

Long press  **【ZERO】**, the total gross weight value and total net weight value will be cleared

### 7.5 Calibration Mode

In this mode, you have to enter the menu and parameter settings module.  
(Refer to Section 10 for the Calibration of the scale system)

## 8. Configurations and Menu Operations



### 8.1 Menu Operations

#### I. Menu Settings





	[ZERO]	[TARE]	[UNITS]	[HOLD]	[CUMULATE]
short press	↑	↓	←	→	✓
long press					add/delete decimal point

#### II. Menu Operations

##### Entering the menu :

Press   at the same time for 1-2 seconds, the indicator will show the password interface:



- Short press  or  → Choosing digit
- Short press  → Increasing the numerical value of the digit
- Short press  → Decreasing the numerical value of the digit

The default password is: P00805.



### III. Menu Layout Structure and Navigation key operation

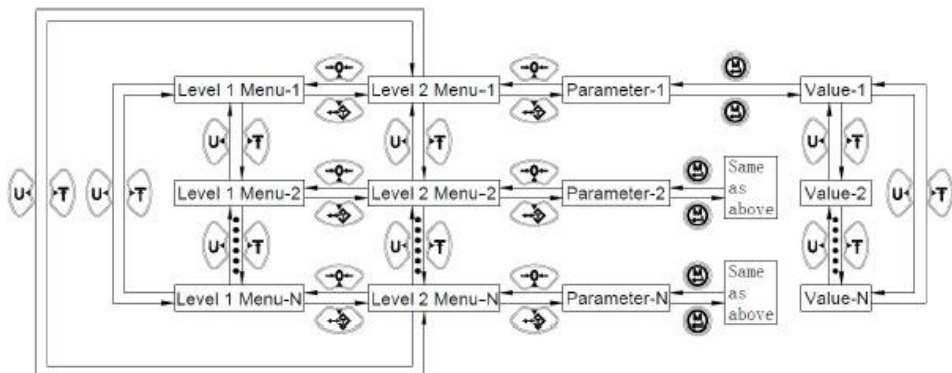

### IV. Menu Structure and Parameter Description

There are 4 directional keys  $\leftarrow, \rightarrow, \uparrow, \downarrow$  to be used for the operation.  $\leftarrow, \rightarrow$  are used for horizontal movement in the same level menu and parameters.  $\uparrow, \downarrow$  are used for moving up and down through different level menus.

Use  $\leftarrow, \rightarrow$  to choose a parameter in a menu and use  $\downarrow$  to move to the next level menu or parameter.

When moving into a parameter of a menu, the indicator shows the previous choice.

If you want to change the parameter values, use  $\leftarrow$  to move into the parameter change status. When the parameter of a menu is a fixed value, use  $\leftarrow, \rightarrow$  to move horizontally. Use  $\leftarrow$  to store the selected parameter and to return to the last menu.

When a parameter value of a menu is editable, directional keys  $\leftarrow, \rightarrow$  are used to edit the digit selected, directional keys  $\uparrow, \downarrow$  are used to increase and decrease the value of the selected digit. Press  $\leftarrow$  to save the input values and exit

In the actual menu structure, the selected menu item is displayed horizontally. The parameter value with the symbol  $\square$  is the default value of system reset.



Level 1 Menu	Level 2 Menu	Description	Parameter Value	Note
USER (Basic parameter Settings)	bEEP	buzzer switch	[on]/off	
	LlE En	Backlight switch	[on]/off	
	LlGht	Background light turn off time/ s	dis/1/2/3/5/[10]/15/20/30/60	"dis" means that the backlight is always on
	R OFF	Auto off time/min	[dis]/1/2/3/5/10/15/20/30/60	"dis" means that the indicator will not be power-off automatically
	PG	Unit kg	[on]/off	
	t	Unit t	on/[off]	
	g	Unit g	on/[off]	
	Lb	Unit lb	on/[off] (related to the software mode)	
	oz	Unit oz	on/[off] (related to the software mode)	
	PLb	Unit Klb	on/[off] (related to the software mode)	
	n	Unit N	on/[off] (related to the software mode)	
	Kn	Unit kN	on/[off] (related to the software mode)	
	Un	User's unit	on/[off] (related to the software mode)	
	Un uAL	User's unit coefficient	Any Number (related to the software mode)	
ouEr (Overload setting)	dFE U PrE	Default unit	kg/t/g/lb/oz/klb/N/kN/UN	
	PrE u	Overload Warning value	[on]/off	See: Note1
	ouEr	Overload Warning value	Any Number	
	ouEr	Overload Alarm	[on]/off	
	ouEr u	Overload Alarm value	Any Number	
hlgH	Historical maximum overload value	(read only)		

<b>CONFIG</b> (Weighing coefficient setting)	InCrE	Division value	0.001/0.002/0.005/0.01/0.02/0.05/0.1/0.2/0.5/0.1/0.2/0.5/[1]/2/5/10/20/50	
	CAP	Rated Weighing	Any Number	
	rATE	Sampling speed / Hz	4.17/6.25/8.33/[10]/12.5/16.7/33.2/50/62/123	
	Stb t	Stability Judgement times / s	0.5/[1]/2	
	Stb r	Stability judgement range / d	0.1/0.2/0.3/0.4/[0.5]/0.75/1/1.25/1.5/1.75/2/2.5/3/3.5/4/5	
<b>CAL</b> (Standard value Calibration)	Eero	Zero A/D count	(read only)	Detailed operating method is as follow: 4.4.1 Detailed method to Standard value Calibration
	LoAd01	Calibrated weight	(read only)	
	~LoAd20 CAL 01	Calibrated point A/D count	(read only)	
	~CAL 20 tARE	Zero offset value	(read only)	
<b>d-CAL</b> (Digit input calibration)	Eero	Input the Zero A/D count	Any Number	Detailed operating method is as follow: 4.4.2 Detailed method to Digit Calibration
	LoAd01 ~LoAd20	Input the corresponding calibration value manually	Any Number	
	CAL 01 ~CAL 20	Input the corresponding calibration A/D code manually	Any Number	
<b>OUT</b> (RS232 setting)	Coñ	Serial communication	on/[off]	
	bAUD	Baud rate / bps	[1200]/2400/4800/9600	
	bit	Output DB	[8n1]/8o1/8e1	See: note 2
	tYPE	Communication mode	[contin ]/reque	See: note 3

rAdi o (Wireless setting)	rF rAt	Wireless transmission frequency	[2Hz]/3Hz/4Hz/5Hz	See: note 4
	Addr	Wireless address	0~255 Any Number	
	rF dSP	Wireless output	on/[off]	
	SEEP	Automatic channel search		
	bAnd	Manual switching channel	1~16	
SYS (system parameter)	GAI n	Wireless gain	1~8	
	uEr	Software version	(read only)	
	rESEt	System parameter reset		Used with caution!
	nōAd	Software mode	[None]/OIML/NTEP/Canada	

## 8.2 Overload

### I. Records Overload

1. This indicator records the real time overload situation. When load weight exceeds the overload alarm set value, the background light flashes (if background light is enabled), the panel shows  (warning), the display flashes, and shows the error message *ouEr*
2. When load weight exceeds the overload alarm set value, the background light flashes (if background light is enabled), the panel shows (warning signs), the display flashes, shows the error message *ALArn*, and the buzzer warns intermittently
3. If, overload weight exceeds the historical maximum overload weight, the historical maximum overload weight will be updated. You can find the maximum overload in the *hi Gh* menu.

### 8.3 Modify Password

Press the ↑, ↓ key, and hold for 1 second, indicator pops up the password interface. *P00000*.

Press the arrow keys ←, →, ↑, ↓ Enter the password 08050, then press ↵ key Display shows the password menu (PWORD). Press ↓ to enter.

The first parameter is the user's password (USER P), press ↓ to enter, display the current password, for example *054321*. Note that the password is effective only within five-digit, one hundred thousand digits will be discarded. Press ↵ key to start modification, press the arrow keys ←, →, ↑, ↓ enter the new password, press ↵ key again to save, press ↑ key to return to the previous menu. Details are as follows:

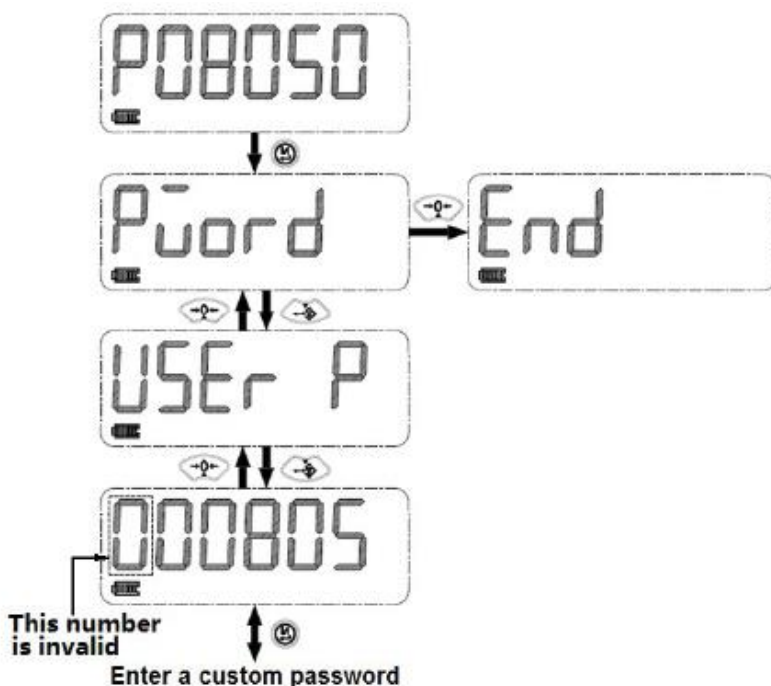

## 9. Communication

The 805HP indicator has two ways in communicating to the scale:

### 9.1 RS232 Communication

The indicator has a standard RS-232 serial output interface to connect to large screen monitors, computers or other peripherals. Its effective connection cable length is 15 meters and beyond this length may lead to a high error rate.

To turn on/off serial communication, enter the configuration menu and press → until the indicator shows `o U t`. Press ↓ to enter the submenu `C o n` and select on/off with ←,→. Press ↵ to confirm selection

#### I. Serial communication baud rate

Serial communication baud rates 1200bps, 2400bps, 4800bps, 9600bps are available. The baud rate is set in the submenu `b R U d` using ←,→. Press ↵ to confirm selection.

#### II. Data frame format

Data frame format is set in `b I t` submenu. Press ↓ to enter the submenu and use the ←,→ to select your desired format. Press ↵ to confirm selection.

Serial output format can be configured as 8N1 / 8O1 / 8E1. 8N1 means 1 start bit, 8 data bits, 1 stop bit, and no parity. 8O1 means 1 start bit, 8 data bits, 1 stop bit, and odd parity. 8E1 means 1 start bit, 8 data bits, 1 stop bit, even parity.

Indicator outputs data in the form of byte frame. Every byte frame is constituted by eight bytes of data, and all the bytes are ASCII.

|=|D0|D1|D2|D3|D4|D5|D7|

Each frame begins with '=' (0x3D).

Each frame contains seven data bytes, including decimal point '.' (0x2E). MSB first, and the LSB follows. If there is a negative sign '-' (0x2D), then it will be transmitted first.

For example, transmit 70.15, that is transmitting | = | | | 7 | 0 | . | 1 | 5 | For example, transmit -32.5, that is transmitting | = | | - | 3 | 2 | | 5 |.

### III. Communication mode

Two communication modes can be selected in *TYPE* submenu. Press ↓ to enter the submenu and use the ←,→, to select your desired communication mode. Press ↵ to confirm selection.

When the parameter is configured to contin, indicator transmits data in the form of one frame after the other.

When the parameter is configured to reque, if and only if the indicator receives ASCII code '@' character, it will send a data frame.

#### 9.2 Wireless Communication

The indicator can operate at 433Mhz and 915Mhz frequencies. The effective distance between the scale and indicator is maximum of 75 meters.

If you need to change the indicator or wireless transceiver, or because of radio frequency interference, you can configure the communication parameters to re-obtain high-quality communications in the following steps:

**Set up a wireless address:** The wireless transceiver has its own independent and fixed communication address with codes 0 - 255. The wireless communication works when the address code of the indicator is consistent with the address of the wireless transceiver. Check *Addr* parameter values of the *Radio* menu and make any necessary changes to match the address code of the wireless transceiver.

**Automatic Channel Search:** After completing the wireless address set up, execute command *SEEP*. Indicator will automatically search the wireless transceiver channels from 1- 16. If the channel search is successful, the indicator will display PASS. If the channel search fails, the indicator displays FAIL. Check if the wireless transceiver power supply is normal, if the communication distance is too far, and if radio frequency interference exists.

**Manually switch channels:** When multiple sets of wireless systems are needed in the same location, wireless systems of the same channel may interfere with each other. To avoid this, you need to manually switch channels. Using different channels to distinguish between different wireless systems will ensure high quality wireless communications. To manually change channels, execute command `band` of the `rAdl` menu. Press `←`, `→` key to choose the designated channel number (1- 16), and press `↵` key to execute the handover command. If the channel matches successfully, the indicator displays PASS. If the channel fails, the indicator displays FAIL. Switching command is repeatable until channel match is successful

**Set communication power:** To set communication power, execute command `power` of the `rAdl` menu. Press `←`, `→` key to and select the power level (1 - 8), press `↵` key to perform the set command. When the power settings are successful, the indicator displays PASS. When the power setting fails, the indicator displays FAIL. Switching command can be executed repeatedly until switched successfully

**Set wireless signal output on/off:** When need to support the use of wireless large screen or other external wireless devices, you can open the wireless signal output. Opening mode: adjust the `RF dsp` menu to `on`

## 10. Calibration and Parameter Settings

The indicator supports multi-point (total 21 points) standard value calibration and multi-point (total 21 points) digit input calibration.

In actual use the indicator can be calibrated by the A/D count, which was recorded during the standard value calibration. The device calibration accuracy has the same accuracy as it is calibrated by standard value calibration.

The following are the requirements in calibration:

- The scale and indicator have established a stable communication
- Test Weights or known weights ( recommended at least 20% of the maximum capacity )

- Make sure Local Gravity is in line with the gravity stored in the indicator, otherwise, change it according to the local gravity value

### 10.1 Standard Value Calibration

The weight calibration consists of the following steps:

- Zero A/D count
- Weight Calibration.
- Calibrated point A/D count
- Zero offset value (Zero offset can be re-corrected when using hooks or chains to hang the test weights.)

The following describes calibration procedures for Standard Value Calibration:

- 1) Enter the configuration menu, the indicator shows **USER**, Remove all loads. If hooks or chains are used to hang the test weights, load the hooks or chains.
- 2) Press → until the indicator shows **CAL**. Press ↵ to move into zero A/D count.
- 3) The indicator shows **Zero**, press ↵ to zero calibration. The indicator shows the A/D count for the zero calibration, e.g. **5 18674**. Press ↵ again to save the value and go to the next menu.
- 4) The indicator shows **LOAD** Load test weights, press ↵. The indicator shows the test weight value, e.g. **000 100**. Press ←, →, ↑, ↓ to input the test weight value. Press ↵ to save the value and go to the next menu
- 5) The indicator shows **CAL 01**. Press ↵ to calibrate span. The A/D count for the span calibration is shown, e.g. **588672**. Press ↵ again to save the calibration value and go to the next menu.

Note: When calibrating with multiple test weights repeat the steps 4 to 5.

- 6) When the indicator shows **ERR**, there are 2 options:
  - 6.1) If no chains or hooks are used to hang the test weights during calibration, remove the test weight and press the start key to finish the calibration and return to weighing mode



6.2) If hooks or chains are used during the calibration, remove these and the test weights. With all weight removed, press  $\swarrow$  to re-zero (this function can be used to remove the tare weight deviation if the hooks or chains are used to hang the test weights). The indicator shows the current A/D count, e.g. 500 187. Press  $\swarrow$  again to finish the calibration and return to weighing

**Suggestion:** When calibrating with standard value calibration, record the A/D count of zero and span calibration, so that you may re-calibrate your indicator simply by entering the recorded A/D count of zero and span calibration with the Digit Calibration method

Detailed diagram for standard value calibration:

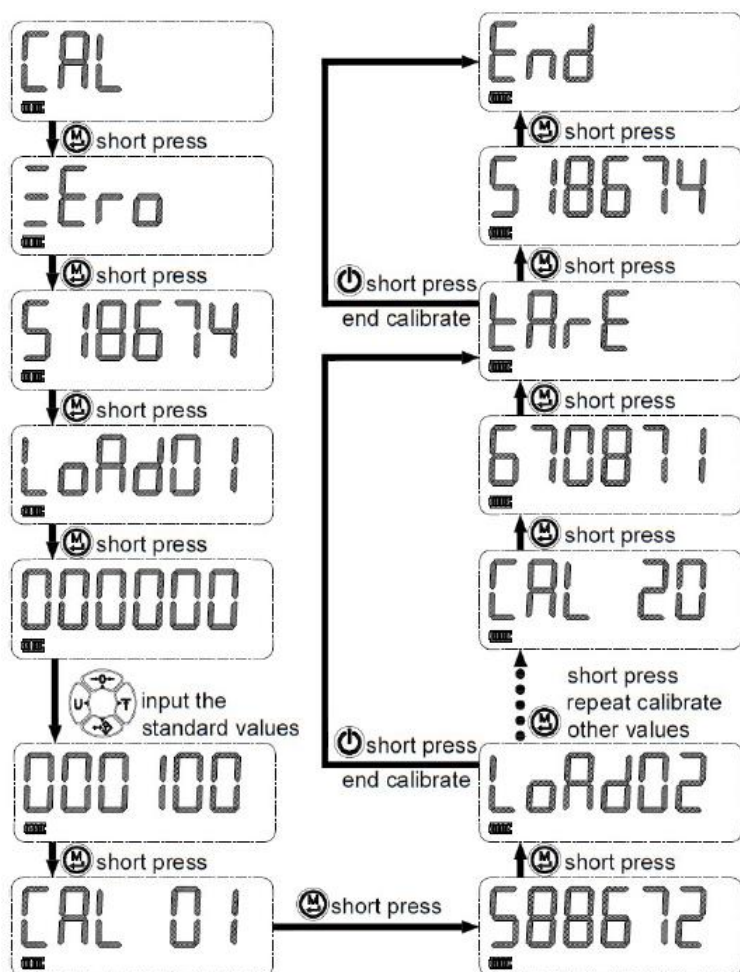

## 10.2 Digit Calibration

Digit calibration is another method in which you can calibrate the scale system without using the actual test weights. The method requires the A/D count recorded from the previous standard value calibration.

The digit calibration consists of the following steps:

- Zero A/D count
- Weight Calibration.
- Calibrated point A/D count
- Zero offset value (Zero offset can be re-corrected when using hooks or chains to hang the test weights.)

The following describes calibration procedure for digit calibration methods:

- 1) Enter the configuration menu, the indicator shows `USER`.
- 2) Press  $\rightarrow$  until the indicator shows `dCAL`. Press  $\swarrow$  to move into zero A/D count.
- 3) The indicator shows `ERR0`. Press  $\swarrow$  and the indicator will show `0000`. Press  $\leftarrow, \rightarrow, \uparrow, \downarrow$  to input the new zero A/D count. Press  $\swarrow$  again to save and go to the next menu.
- 4) The indicator shows `LOAD0`. Press  $\swarrow$  and the indicator will show `0000`. Press  $\leftarrow, \rightarrow, \uparrow, \downarrow$  to input the new test weight value. Press  $\swarrow$  to save and go to the next menu.
- 5) The indicator shows `CAL 01`. Press  $\swarrow$  and the indicator will show `0000`. Press  $\leftarrow, \rightarrow, \uparrow, \downarrow$  to input the new Span A/D count. Press  $\swarrow$  again to save and finish the digit calibration.

Note: When calibrating with multiple test weights repeat the steps 4 to 5

- 6) When the indicator shows `ERR`, there are 2 options:
  - 6.1) If no chains or hooks are used during the standard value calibration, press the start key to finish the calibration and return to weighing mode

6.2) If hooks or chains are used during the standard value calibration, press ←, →, ↑, ↓ to input the re-zero A/D count. Press M again to save and finish the digit calibration and return to weighing mode

Detailed diagram for digit calibration:

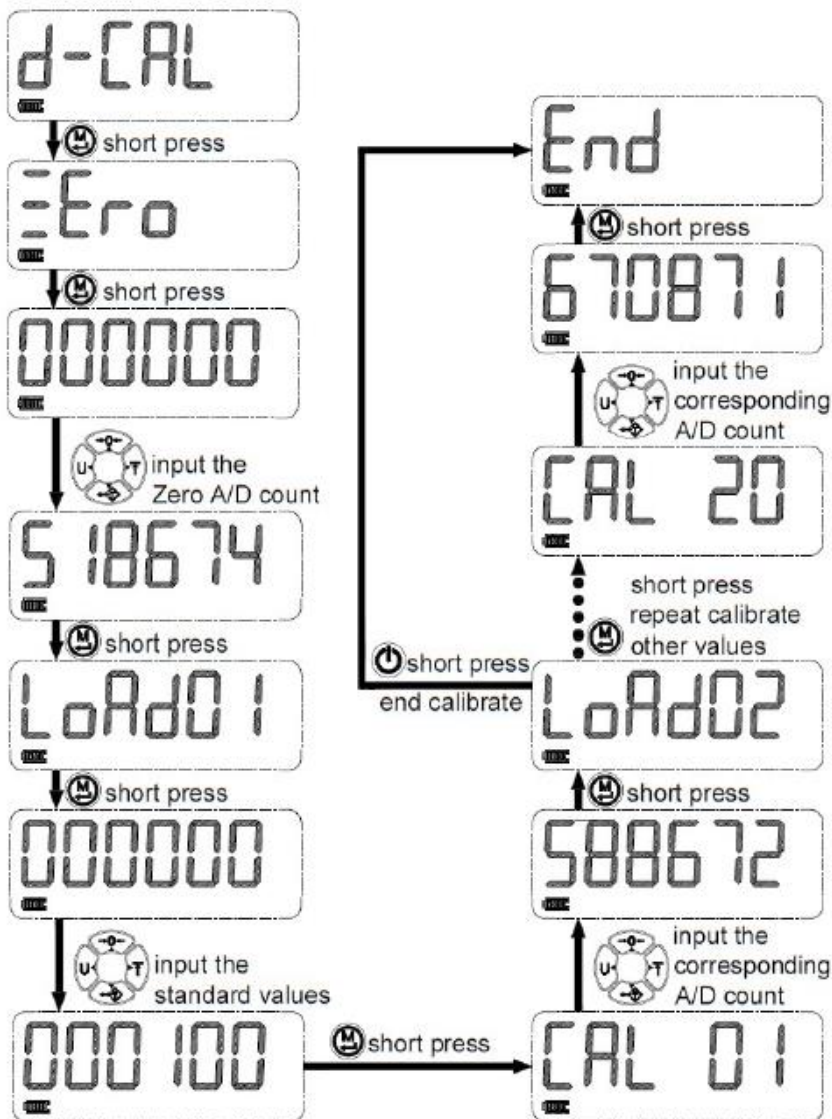

## 11. Troubleshooting Guides

PROBLEM	POSSIBLE CAUSE	SOLUTION
No display in the indicator	Defective battery	Replace
	Defective button/s	Requires authorized service
	Power button not properly pressed	Press and hold ON/OFF key for three seconds
Digits flash (indicator)	Low battery	Replace battery
Display does not respond to load changes	Faulty load cell	Requires authorized service
	Out of calibration	Re- calibration
Displayed weight shows large error	Scale is not Zeroed before applying weight	Press ZERO before applying weight
	Requires recalibration	See calibration
	Units (Kg/lb) wrong selection	See operation
Wireless distance shortened	Wireless indicator's battery is low	Replace battery.
	Adjust the RF Power output in the indicator	See operation

## 12. Technical Specifications

Features & Specifications	805HP-WL (Wireless Indicator)	805HP (Wired Indicator)
Electrical Performance:		
Link Connection/Interface	Frequency-16 available channels to avoid interference (duplex).	Wired with RS-232 compatible interface

Non-linearity	±0.001%F.S. Max	
Zero Temp. Drift	±10nV/°C	
Max. Capacity Temp. Drift	±3ppm/°C Max	
Max. Display Resolution	1/10,000	
Min. Input Sensitivity	0.3 μV/e	
Input signal range:	0mV~±25mV	
Load cell Excitation Voltage	1.22Vdc	
Power Supply	3 x AA 1.5V alkaline batteries	
Display:		
Display	6-digit panoramic FSTN LCD with LED back light	
Sampling Frequency	4.17/6.25/8.33/10/12.5/16.7/33.2/50/62/123Hz are user-selectable.	
Display content	Display can show a positive or negative number, and decimal point can be selected to any position.	
Units of Measurement	kg/lb/t/g/oz/klb/N/kN/ are user-selectable units. Measurements units can be enabled independently and switched. The default unit can be selected.	
Enclosure material	ABS	
IP Rating	IP65	
Ports	RS-232C (optional)	RS-232C (optional)
Functions:		
Overload protection	User-selectable overload warning value and alarm value. Overload warning and alarm can be enabled or disabled Overload alarm peak records can be reviewed	
Functions	21 set-points calibration, Zero scale, Tare, Low battery warning, Peak-hold.	
Power-down storage	Date can be saved after power-off. Date can also be saved after removing batteries.	
Power-saving	If inactive for a period of time set by user, the auto power-saving mode will activate. If inactive for a period of time set by user, the auto power-off mode will activate.	
Functions :		
Zero	Yes	
Tare In / Tare Out	Yes	

Hold	Yes ( with Peak Hold )
Low Voltage Alarm	Yes
Battery Supervision	Yes
Overload Alarm / Record	2 Alarm Set Point ( Lower and Higher ) - records overload
Calibration	2-set-points calibration is required for linearity correction
Digital Calibration	Yes
Unit Switch	Kg, g, t, lb, Klb, N, kN, oz, User's defined unit
Gravity Acceleration Switch	Yes
Tare Set	Yes
Total / Delete / Clear Total	Yes
View Total	Yes
Resolution Switch	Yes
Auto-Off Set	Yes
Idle Set	Yes
Tare Range	100% F.S.
Zero Range	4% F.S.

### 13. Appendices

#### 13.1 Seven-segment digital display alphanumeric table

0	1	2	3	4	5	6	7	8	9		
0	1	2	3	4	5	6	7	8	9		
A	B	C	D	E	F	G	H	I	J	K	L
A	B	C	D	E	F	G	H	I	J	K	L
M											
n	o	p	q	r	s	t	u	v	w	x	y
N	O	P	Q	R	S	T	U	V	W	X	Y
Z											

#### 13.2 Gravitational acceleration in different countries

Acceleration Due to Gravity, g in m/s<sup>2</sup>

Country	City	G-Constant	Country	City	G-Constant
Argentina	Buenos Aires	9.7979	Mexico	Mexico City	9.7799
Australia	Sydney	9.7979	Morocco	Rabat	9.7964
Austria	Vienna	9.8099	Netherlands	Amsterdam	9.8129
Belgium	Brussels	9.8114	New Zealand	Wellington	9.8039
Belize	Manamah	9.7904	Norway	Oslo	9.8189
Bolivia	La Paz	9.7844	Panama	Panama City	9.7814
Brazil	Brasilia	9.7889	Peru	Lima	9.7829
Canada	Montreal	9.8069	Philippines	Manila	9.7844
	Ottawa	9.8069	Poland	Swider	9.8159
	Toronto	9.8054	Portugal	Lisbon	9.8009
	Vancouver	9.8099	Rumania	Bucharest	9.8054
Check Republic	Prague	9.8114	Saudi Arabia	Riyad	9.7904
Chile	Santiago	9.7979	Scotland	Stockholm	9.8189
China	Hong Kong	9.8099	Singapore	Singapore	9.7814
Colombia	Bogota	9.7799	South Africa	Johannesburg	9.7919
Costa Rica	San Jose	9.7829	Spain	Madrid	9.8024
Cypruss	Nicosia	9.7979	Switzerland	Bern	9.8084
Denmark	Copenhagen	9.8159	Taiwan	Taipei	9.7904
Ecuador	Quito	9.7724	Tunisia	Tunis	9.7799
Finland	Helsinki	9.8189	Turley	Ankara	9.8024
Germany	Dusseidorf	9.8129	Uruguay	Montevideo	9.7964
Great Britain	London	9.8144	USA	Anchorage	9.8189
Greece	Athens	9.8009		Atlanta	9.7964
Guatemala	Guatemala City	9.7844		Boston	9.8039
Hungary	Budapest	9.8069		Chicago	9.8024
Indonesia	Djakarta	9.7814		Dallas	9.7949
Iraq	Baghdad	9.7964		Detroit	9.8039
Japan	Mishima	9.7979		Los Angeles	9.7979
Korea	Seoul	9.7994		New York	9.8024
Kuwait	Kuwait	9.7919		Philadelphia	9.8024
Lebanon	Beirut	9.7964		San Francisco	9.7994
Mauritius	Port Louis	9.7859	Venezuela	Caracas	9.7829

**Anyload Transducer Co. Ltd**

Website: [www.anyload.com](http://www.anyload.com)

Email: [info@anyload.com](mailto:info@anyload.com)

Fax: +1 866 612 9088

North America Toll Free: 1-855-ANYLOAD (269 5623)