

ANYLOAD®

805TS & 805BS Series

General Purpose Digital Weight Indicators

Operations Manual (v1702)

- 805TS-B-17
- 805BS-B-17
- 805BS-TN-B (*Lite Version*)



TABLE OF CONTENTS

1.	Introduction	3
2.	Safety Recommendations	4
3.	Operation Modes	5
4.	Front Panel Keypad	6
5.	Indicating Lights	7
6.	Start Up	8
7.	Operations	8
	7.1 Normal Weighing Mode	8
	7.1.1 Gross/Net Mode	9
	7.1.2 Units	9
	7.1.3 Zero Scale	9
	7.1.4 Acquire Tare	9
	7.1.5 Remove Stored Tare Value	9
	7.1.6 Print	9
	7.2 Peak Mode Operations	10
	7.2.1 Units	10
	7.2.2 Peak/Normal Weighing Mode	10
	7.2.3 Remove Peak Mode Value	11
	7.2.4 Zero Scale	11
	7.2.5 Print	11
	7.3 Count Mode Operations	11
	7.3.1 Gross/Net Mode	12
	7.3.2 Units	12
	7.3.3 Zero Scale	12
	7.3.4 Acquire Tare	12
	7.3.5 Remove Stored Tare Value	12
	7.3.6 Input Item Code	12
	7.3.7 Printing in Count Mode	13
	7.3.8 Fast Setup of Count Items Average Weight	13
8.	Wire Installation	14
	8.1 DC power supply	15
	8.2 SW2 Switch	15
	8.3 KOUT: Relay signal outputs	15
	8.4 SW3: Output: RS485/COM	15
	8.5 SW4: Output: USB/RS232	15
	8.6 Load Cell Input	15
	8.7 COMM: Serial Communication port	16
	8.8 Printers	16
9.	Configurations	16

9.1	Front Panel Configurations	17
9.2	Menu Structure and Parameters Descriptions	18
9.2.1	F1(Configuration) Menu	20
9.2.2	F2(Format) Menu	23
9.2.3	F3(Calibration) Menu	26
9.2.4	F4(Serial) Menu	27
9.2.5	F5(Mode) Menu	29
9.2.6	F6(Relay) Menu	30
9.2.7	F7(Ver) Menu	32
9.2.8	F8(PFormat) Menu	33
10.	Calibration	33
11.	Count Items Average Weight Setup	37
12.	Relay Output Setup	39
13.	Print Format	41
13.1	Print Format Commands	42
13.2	GFMT and NFMT Print Format Input	43
13.3	Default Formatting	44
13.4	Print Consecutive Number	45
13.5	Date and Time Settings	46
14.	Serial Communication	47
14.1	Continuous Transmission	47
14.2	Transmission Upon Request	48
14.2.1	Data Transmission Sequence	49
14.2.2	Communication Command	50
14.3	Serial Communication Test	51
15.	Appendices	52
15.1	Error Messages	52
15.2	Software Version and Default Configuration Parameters	53
15.2.1	Find out indicator software version	53
15.2.2	Restore Factory Setup Parameters	53
15.3	Technical Specifications	55
15.4	ASCII Codes Table	56
15.5	Indicator Display Characters	57

1. Introduction and Product Features

Thank you for choosing Anyload General Purpose Digital Weight Indicators. The 805TS and 805BS series indicators are general purpose indicators that provide high accuracy and reliability with multiple functions. These indicators have an A/D adopted conversion technology of a 24-bit resolution with a rate of conversion of up to 960 cycles per second and drives up to eight 350Ω or sixteen 700Ω load cells. With a SS304 stainless steel wash down enclosure, the 805TS and 805BS are ideal for food industry, agricultural industry, and industrial applications. These indicators are NTEP III/IIIL, 10000 and Measurement Canada III, 10000; III HD 20000 approved.

Key Features:

805TS	805BS Series
Parameter settings and calibration procedures are performed at the front panel	
Auto zero scale can be selected when switching on indicator	
Auto zero tracking	
Unit exchange between kg & lb	Unit Selection: kg, lb, g, oz, lb:oz
0.8 in (20mm) in height red LED display and with option for blue LED	143mm x 41mm LCD white background and blue font display, and with option for blue background and white font
Improper operation and fault indication	
Normal Weighing mode, Peak mode and Count mode functions	
2 way relay signal output (not available in 805BS-TN-B Lite Version)	
Zero Scale, Tare mode, Gross/Net weight selections	
Equipped with RS232C and RS485 connecting port with options for Data Transmitted Continuously and Data Transmitted Upon Request	
Print functions with programmable print format (with build-in clock to show dates and hours	
Can drive up to eight 350Ω or sixteen 700Ω load cells through a junction box	

This manual provides installation, operation and configuration information of indicator models 805TS and 805BS series. It is recommended to go through the manual in details before installing, operating or configuring the indicator.

Checking What is in the Box:



805TS or 805BS indicator



Operations Manual



Power Adapter for 805TS & 805BS series

2. Safety Recommendations

Important instructions, which involve safety, are highlighted with the appropriate mark:



When it is required to work inside the indicator enclosure for some procedures described, the work can only be performed by qualified technical personnel.

When using the equipment in surroundings with increased safety requirements, the corresponding regulations must be observed:

The indicator may only be used with the power adapter supplied exclusively for use with the device.

Before inserting the power adapter, the user must ensure that the operating voltage stated on the power adapter agrees with the mains voltage.

If not, please contact Anyload Customer Service.

If the power adapter or its cable is damaged, the indicator must immediately be disconnected from the electricity supply (pull out the power adapter).

These operating instructions must be read by each operator of the equipment and must be available at the workplace at all times.

3. Operation Modes

❖ Weighing Mode

When SW2 switch is switched to off, indicators are in the weighing mode for 805TS and 805BS Series. Refer to Section 8 on switching configurations and weighing mode.

In F5.1 Menu, three different Weighing modes can be selected (refer to F5.1 Menu):

- (1) **Normal Weighing mode:** Indicator displays gross weight or net weight in this mode. Unit of the displayed weight is highlighted by indicator light and different units can be toggled (refer to Section 7.1).
- (2) **Peak mode:** Indicator displays peak value of load acted upon the weighing instrument (refer to Section 7.2).
- (3) **Count mode:** Indicator displays number of weighed items having the same weight (refer to Section 7.3).

❖ Configurations Mode

When SW2 switch is switched to on, indicators are in the configurations mode. Refer to Section 8 on switching configurations and weighing mode.

Most of the operation data settings including parameters setting and weighing range calibration are to be carried out in Configurations mode.

Remove the back panel of indicator (refer to Fig 8.1 Sockets on Circuit Board). Switch on SW2 jumper located at the lower corner. Indicator will be in Configurations mode and display shows “F1”. Refer to Section 9 for details.

4. Front Panel Keypad

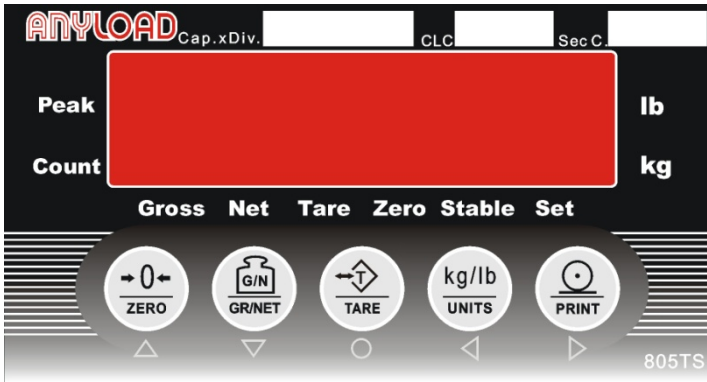

Fig. 4.1 Front Panel Configuration for 805TS

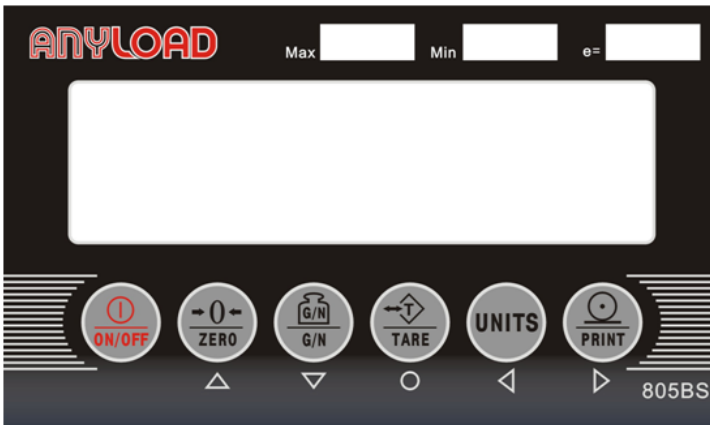







Fig. 4.2 Front Panel Configuration for 805BS series

Fig.4.1 and Fig.4.2 shows indicator display, LED/LCD indicator lights and keypad configuration. Signs at the bottom of the keypad are for configuration operation use (refer to Section 9 for details).

The signs are for inputting item codes in Count Mode (refer to section 7.3 for details).

5. Indicating Lights and Symbols

Indicating Lights for 805TS	Indicating Symbols for 805BS Series
<p>“Peak”— Light is on when operating in Peak mode</p>	<p>“  ”—Peak, The symbol is displayed when operating in Peak mode</p>
<p>“Count”— Light is on when operating in Count mode</p>	<p>“  ”—Count, The symbol is displayed when operating in Count mode</p>
<p>“kg”— Light is on when display showing units in kg.</p>	<p>“kg”— The symbol is displayed when display showing units in kg.</p>
<p>“lb”— Light is on when display showing units in lb.</p>	<p>“lb”— The symbol is displayed when display showing units in lb.</p>
<p>N/A</p>	<p>“g”— The symbol is displayed when display showing units in g</p>
<p>N/A</p>	<p>“oz”— The symbol is displayed when display showing units in oz</p>
<p>N/A</p>	<p>“lb:oz”— The symbol is displayed when display showing units in lb:oz.</p>
<p>“Gross”— Light is on when display showing gross weight</p>	<p>“  ”— Gross, The symbol is displayed when display showing gross weight.</p>
<p>“Stable”— Light is on when load is stable or within the preset dynamic load range (refer to F1.4 Menu for dynamic load setting).</p>	<p>“  ”— Stable, The symbol is displayed when load is stable or within the preset dynamic load range (refer to F1.4 Menu for dynamic load setting).</p>
<p>“Zero”— Light is on when load is within zero range (<1/4d).</p>	<p>“  ”— Zero, The symbol is displayed when load is within zero range (<1/4d).</p>
<p>“Tare”— Light is on when Tare setting is not zero</p>	<p>“  ”— Tare, The symbol is displayed when Tare setting is not zero</p>

6. Start up

Connect power supply. For the 805TS, the indicator automatically goes through a self checking process (showing all 0 to all 9, decimal point and indicator lights). For the 805BS series, pressing on the ON/OFF button on the front panel for 2 seconds to turn on the power. Once on, the indicator will proceed with the self checking process. There are two possible outcomes depending on F1.8 and F1.9 Menu settings:

- When indicator is set to Auto Zero and Manual Zero (F1.8=0 and F1.9=0, respectively and the load on the scale is within the zero scale setting in F1.3 Menu, the indicator zeros automatically or manually and display shows "0".
- Otherwise if F1.8=1 & F1.9=1, the indicator is set not to Auto Zero/Manual Zero. If the load exceeds the zero scale setting in F1.3 Menu, display shows actual load.

Refer to F1.3 Menu along with the F1.8 & F1.9 Menu for further information.

7. Operations

The indicator goes to Weighing mode when the SW2 switch is turned off. Under the Normal Weighing mode, the Peak mode and Count mode can be set at F5.1 Configurations Menu (refer to F5.1 Menu).

7.1 Normal Weighing Mode

When the indicator is set to Normal Weighing Mode, the parameter value in F5.1 should be F5.1=0 (refer to F5.1 Menu).

For 805TS (F5.1=0), the "Peak" light and "Count" light are off. Indicator is in Normal Weighing mode.

For the 805BS series(F5.1=0), both "Peak" and "Count" symbols won't appear in the display. Indicator is in Normal Weighing mode.

Basic operations in Normal Weighing mode:

7.1.1 Gross/Net Mode

Press **【GR/NET】** , change to Net weight from Gross weight or vice versa. When tare weight is stored (indicator has stored tare weight value other than 0),

Net weight shown on the display is equal to Gross weight minus the Tare weight. For the 805TS series, the "Gross" light is on when indicating gross weight and the "Net" light is on when indicating net weight while the 805BS series, the "Gross" symbol is displayed when indicating gross weight and "Net" symbol is displayed when indicating net weight.

7.1.2 Units

When parameter in F6.1 menu is set to OIML or NONE mode, press the **【UNITS】** button in changing units. But if F6.1 is set to NTEP or CANADA, the unit toggling is not allowed. For 805TS series, the corresponding lights on the far right side of the screen indicate which unit type is currently set while for 805BS series, the unit symbol appears in the display like Kg, lb or Oz.

7.1.3 Zero Scale

When in Gross mode ("Gross" light is on for 805TS series, or for the 805BS series, "Gross" symbol is displayed), remove the load from scale and wait until the "Stable" indication is present. Press **【ZERO】** and the "Zero" light will turn on (805TS series) or the "Zero" symbol will be displayed (805BS series). This indicates that the Zero Scale setting is complete

7.1.4 Acquire Tare

When no Tare is stored ("Tare" light is off), place the container on the scale and wait until the "Stable" indication is present. Press **【TARE】** , this will store the Tare weight. If "Net" light is on (805TS series) or the "Net" symbol is present (805BS series), the display shows the Net weight (refer to F6.1 Menu).

7.1.5 Remove Stored Tare Value

When a tare weight is stored ("Tare" light is on or "Tare" symbol is displayed), press **【TARE】** to remove the stored tare value. The display will show the Gross weight while the "Gross" light (805TS series) is on or the "Gross" symbol is displayed (805BS series)(refer to F6.1 Menu).

7.1.6 Print

Ensure that the "Stable" indication is on, then press **【PRINT】** . Data from indicator is then transmitted to a serial printer for printing. After each printing,

the Consecutive Number is increased by 1. The print format is set according to F8 Menu (refer to Section 13 for Print Format).

7.2 Peak Mode Operations

Only when F6.1 Menu is set to None mode, the F5.1 Menu can be set to Peak Mode. If F5.1=1, the “Peak” light will turn on (805TS series), or the “Peak” symbol will appear (805BS series) and the indicator will be in Peak mode (refer to F5.1 Menu setting).

When in Peak mode, the display shows gross weight. Press the **【GR/NET】** button to switch between Peak and Normal Weighing modes. Press the **【TARE】** button to cancel Peak mode.

Basic operations in Peak mode include:

7.2.1 Units

When Peak mode operation is deactivated (“Set” light is off for 805TS and “Set” symbol is not displayed for 805BS), pressing the **【UNITS】** button will display the available units like kg, lb, or oz. Corresponding unit indicating the light is on for 805TS while indicating symbol is displayed for 805BS

When Peak mode operation is activated (“Set” light is on for 805TS and “Set” symbol is displayed for 805BS)), the **【UNITS】** button does not function to show available units.

7.2.2 Peak/Normal Weighing Mode

When “Set” light is on (805TS) or “Set” symbol is displayed (805BS), the Peak mode is activated. The display shows the maximum value of load which has been applied to the load cell. When the load is removed, the display still shows the peak load.

Pressing **【GR/NET】** can change indicator from Peak mode to Normal Weighing mode, or vice versa

When “Set” light is off (805TS) or “Set” symbol is not displayed (805BS), Peak mode is deactivated. The value shown on the display changes according to the load applied to the load cell.

7.2.3 Remove Peak Mode Value

During the Peak mode, remove the load and press **【TARE】** button, the current Peak mode value will be reset and the indicator will start for another Peak mode operation.

7.2.4 Zero Scale

During the Peak mode, pressing the **【GR/NET】** button will switch the indicator to Normal Weighing mode or vice versa.

Remove the load and when the “Stable” indication is present, press **【ZERO】** . The display will show the zero value.

7.2.5 Print

When Peak mode is on (“Set” light is on or symbol is displayed), pressing the **【PRINT】** button will print the Peak value. When the Peak mode is off (“Set” light is off or symbol is not displayed), pressing the **【PRINT】** button will print the current load value. After each printing, the Consecutive Number is increased by 1. The Print format can be set at F8 Menu (refer to Section 13 for Print Format). To print Peak value, ensure that it has been set up properly in the Print format settings.

7.3 Count Mode Operations

Only when F6.1 Menu is set to None mode, F5.1 Menu can be set to Count mode. If F5.1=2 the indicator will turn to Count Mode- “Count” light is on for 805TS series or “Count” symbol is displayed for 805BS series. The indicator will now perform Count mode operations (refer to F5.1 Menu).

Basic operations in Count mode:

7.3.1 Gross/Net Mode

Pressing the **【GR/NET】** button will switch between Gross and Net weight mode. When in Tare mode, Net weight is equal to Gross weight minus Tare weight. The “Gross” light is on (805TS series) or the “Gross” symbol is displayed (805BS series) when in Gross mode and the “Net” light is on (805TS series) or the “Net” symbol is displayed (805BS series) when in Net mode.

7.3.2 Units

Pressing the **【UNITS】** button will switch between the weight of load and the quantity of count items. When showing the weight of load, follow F2.3 Menu to choose the unit (refer to F2.3 Menu). When showing the quantity of count items, the display shows “nxxxxx”. xxxxx is the quantity of count items.

7.3.3 Zero Scale

When in Gross mode (for 805TS series, the “Gross” light is on; for 805BS series the “Gross” symbol is displayed), remove the load from scale. After the “Stable” light is on (805TS series), or the “Stable” symbol is displayed (805BS series), pressing the **【ZERO】** button the “Zero” light or symbol will be on. The Zero Scale setting is now complete.

7.3.4 Acquire Tare





When no Tare is stored (“Tare” light or symbol is off), place the container onto the scale and wait until the “Stable” light is on (805TS series), or “Stable” symbol is displayed (805BS series). Press **【TARE】** and Tare value (weight of container) is stored. The display will show the Net weight and the “Net” light (805TS series) will be on, or the “Net” symbol will be displayed (805BS series) (refer to F6.1 Menu).

Note: Only when the tare value displayed is less than 6 digits the tare value can be successfully stored, otherwise, the tare option will not activate.

7.3.5 Remove Stored Tare Value

When a tare value is stored (for the 805TS series, the “Tare” light is on; for the 805BS series, the “Tare” symbol is displayed), press **【TARE】** to remove the stored value. The display will show the Gross weight and the “Gross” light (805TS series) will be on, or the “Gross” symbol (805BS series) will be displayed (refer F6.1 Menu).

7.3.6 Input Item Code

When in Count Mode, press **【PRINT】** to go to Input Item Code status. Display shows “P= xx”, where xx is the code number of the current count item and x flashes. Now the functions of the keypad become , , , , .

▶, ◀ are for moving forward and backward while ▲, ▼ are for increasing and decreasing the digits. After done with Input Item Code, press the ○ key if the stored Item Code is not 0. Item Code of the current count items is then stored and the keypad returns to normal operating functions as shown in Fig. 4.1 (805TS series) and Fig.4.2 (805BS series).

If the stored Item Code =00, display goes to the Fast Setup of the Averaging Weight of the Count Item (refer to Section 7.3.8).

7.3.7 Printing in Count Mode

If the display is showing the weight of the load, the 【PRINT】 key is reserved for entering the count code settings. If the display is showing the quantity of count items, the 【PRINT】 key will print either the GFMT or NFMT text depending if the indicator is in Gross or Net mode.

7.3.8 Fast Setup of Count Items Average Weight

To obtain the average weight of a count item without going into the Configuration mode, follow these procedures below:

- (1) Enter the Input Item Code according in Section 7.3.6. Set the Item Code =00. Display shows “P = 00”.
- (2) Remove all weights from the scale. Press ○ to zero the scale. Display shows “CAL” while calibration is in progress.
- (3) After zeroing the scale, display proceeds to Count Items Average Weight Setup. Use ◀, ▶ to select the suitable sample quantity. Select a larger quantity for lighter count items.
- (4) After selecting a suitable quantity and placing the respective quantity of count items on the scale ,press ○, the display shows “CAL” while calibration is in progress. When complete, there are two possible outcomes:
 - Display shows “- - E5 - -” when the average weight of the count items is too small then there are two options:
 - Combine a few count items to become one count item. Place the same quantity of count items to the scale as per the

sample quantity set in (3) above. Press  to calculate the average weight.

- Press  to cancel Count Items Average Weight Setup and

return to the Weighing mode.

- Display shows the count items average weight and returns to the Weighing mode.

(5) On the Weighing mode, keypad functions are according in Fig.4.1 (805TS and Fig.4.2 (805BS series).

Note: In this procedure, the settings for count items average weight will be erased once the indicator is switched to other mode or the indicator is restarted. If you want to save a count items average weight settings refer to section Section 11.

8. Wire Installation.

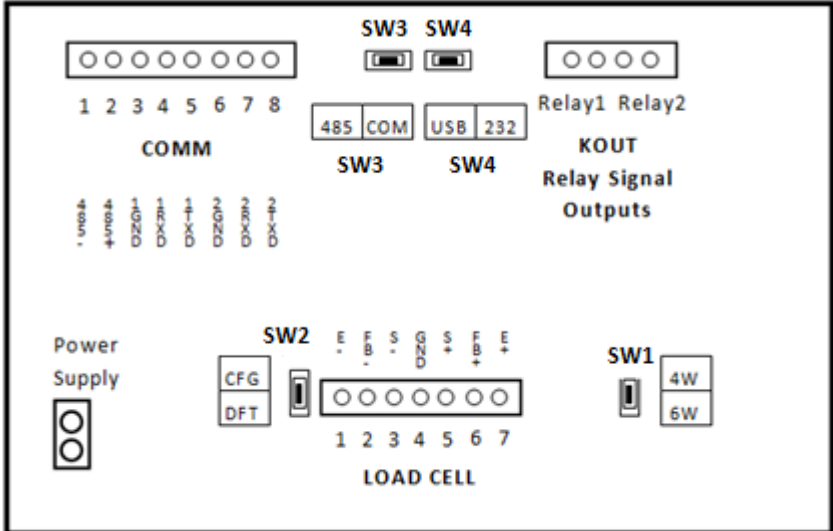

Fig. 8.1 Sockets on Circuit Board for 805TS & 805BS series

*Note: When connect to 4-wire load cell, please turn SW1 ON.
When connect to 6-wire load cell, please turn SW1 OFF.*

8.1 Power supply

805TS-B-17	Input : 120VAC, 60Hz, 110mA Output : 9VDC 600mA
805BS-B-17 & 805BS-TN-B	Input : 120VAC, 60Hz, 110mA Output : 12VDC 400mA

8.2 SW2 Switch

The SW2 switch is used to switch between calibration and normal weighing mode. When it is turned ON the indicator is in calibration mode, otherwise it is in normal weighing mode.

8.3 KOUT: Relay signal outputs

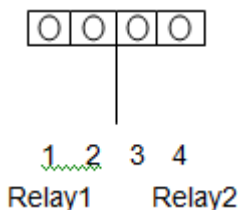

Relay Output of 805TS-B-17 & 805BS-B-17

8.4 SW3: Output: RS485/COM

SW3 switch is used to switch between output RS485 and COM mode. When RS485 output mode is turned ON (left), the RS485 output mode is activated; otherwise the COM output mode is activated.

Note: Only 805TS-B-17 & 805BS-B-17 have this option (not equipped in 805BS-TN-B).

8.5 SW4: Output: USB/RS232

SW4 switch is used to switch between output USB and RS232 mode. When USB output mode is turned ON (left), the USB output mode is activated; otherwise the RS232 output mode is activated.

8.6 Load Cell Input

805TS-B-17, 805BS-B-17 & 805BS-TN-B	
1 (E-)	— Excitation-
2 (FB-)	— Sense-
3 (S-)	— Signal-
4 (GND)	— Signal ground
5 (S+)	— Signal+
6 (FB+)	— Sense+
7 (E+)	— Excitation

8.7 COMM: Serial Communication port

805TS-B-17, 805BS-B-17 & 805BS-TN-B	
1 (485-)	— RS485-
2 (485+)	— RS485+
3 (1GND)	— Signal ground (connect to computer)
4 (1RXD)	— RS232C Receipt port 1
5 (1TXD)	— RS232C Output port 1
6 (2GND)	— Signal ground (connect to computer)
7 (2RXD)	— RS232C Receipt port 2 (Printer)
8 (2TXD)	— RS232C Output port 2 (Printer)
Note: RS485 is not available in 805BS-TN-B	

8.8 Printers

When hooking up a printer to the indicators 805TS & 805BS series use connections 2GND, 2RXD, and 2TXD shown in Fig.8.1. To ensure the indicator is able to print on command set the serial mode (F4.3) equal to comm (1).

9. Configurations

Configure the indicator in the following steps:

- Remove the back panel of indicator.
- Turn on the SW2 switch.
- Indicator will now be in Configuration mode and display shows “F1” - the first Menu item of Level 1 Submenu.
- When configuration is completed, turn off the SW2 switch to exit from Configuration mode.

9.1 Front Panel Configurations

When configuring the indicator the keypad functions are shown in Fig. 9.1.1 and Fig 9.1.2

Table 9.1 Basic Functions of Level 1 menu:

Menu		Menu Function
F1	Config	Configure graduations, zero tracking, zero range, motion band, overload, sample rate, digital filtering and zero scale. See Section 9.2.1.
F2	Format	Set decimal point location, display divisions, display rate and display unit. See Section 9.2.2.
F3	Calibration	Calibrate indicator. See Section 9.2.3 and Section 10.
F4	Serial	Configure serial communication ports. See Section 9.2.4 and Section 14.
F5	Mode	Set weighing mode and unit weight of counted items. See Section 7, Section 9.2.5 and Section 11.
F6	Relay	Set Relay operation modes. See Section 9.2.6 and Section 12.
F7	Ver	Indicate software version and regenerate default configuration parameters. See Section 9.2.7 and Appendix 15.2.
F8	PFormat	Set print format. See Section 9.2.8 and Section 13.

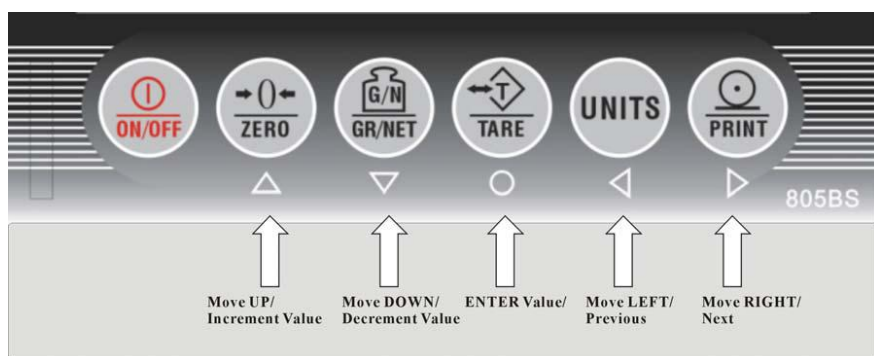

Fig. 9.1.1 Keypad functions in Configuration Mode for 805BS series

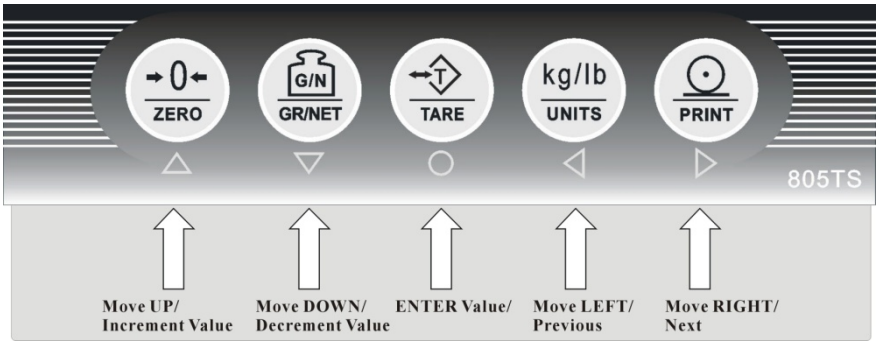

Fig. 9.1.2 Keypad functions in Configuration Mode for 805TS series

9.2 Menu Structure and Parameters Description

Menu structure is shown in flow diagram. In the actual Menu structure, the selected Menu item is displayed horizontally. In most Menus, set parameters and parameter value are shown in tables. “number” is editable values. The default values for each indicator are:

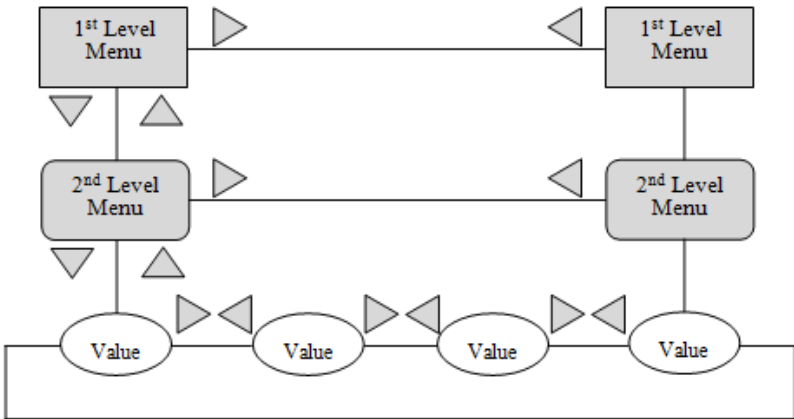

Fig. 9.1.3 Menu Configuration Flow Diagram

There are 4 directional keys \blacktriangleright , \blacktriangleleft , \blacktriangleup , \blacktriangledown to be used for configuration operation. \blacktriangleright , \blacktriangleleft are for horizontal movement in the same level menu and parameters. \blacktriangleup , \blacktriangledown are for moving up and down through different level menus. \bigcirc is for confirming a choice of parameter in a menu.







Use ,  to choose a parameter in a menu and use  to move to the next level menu or parameter. When moving into a parameter of a menu, display shows the previous choice. When the parameter of a menu is a fixed value, use ,  to move horizontally and use  to store the selected parameter and to return to the last menu. When a parameter value of a menu is editable as shown in Fig 9.1.4, directional keys are used to edit the digit selected, and to increase or decrease the value of the selected digit.



Fig. 9.1.4 Editable Parameter

9.2.1 F1 Configuration Menu

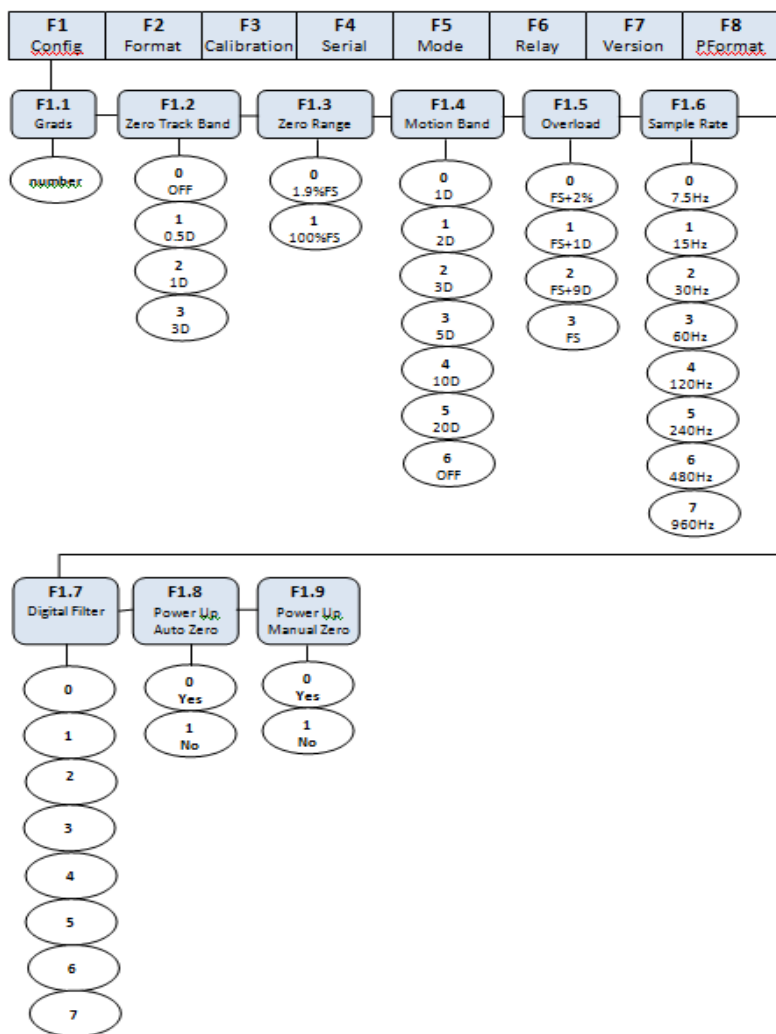

Fig. 9.2.1.1 F1 (Configuration) Menu Structure

Table 9.2.1 F1 (Configuration) Menu Parameters

		F1 (Configuration) Menu
Parameter	Choices	Description
Level 2 Submenu		
F1.1 (Grads)	<i>number</i>	<i>Graduations.</i> Specifies the number of full scale graduations. Graduation=Capacity/Display Divisions. Display divisions for primary and secondary units are specified in the F2 (Format) Menu.
F1.2 (Zero Track Band)	0 (OFF)	<i>Zero track band.</i> Automatically zeros the scale when within the range specified, as long as the input is within the configured zero range. Selections are ± display divisions.
	1 (0.5D) <input checked="" type="checkbox"/>	
	2 (1D)	
	3 (3D)	
F1.3 (Zero Range)	0 (1.9%FS) <input checked="" type="checkbox"/>	<i>Zero range.</i> Selects the range within which the scale can be zeroed. The 1.9% selection is ±1.9% around the calibrated zero point, for a total range of 3.8% FS. FS=Grads * D
	1 (100%FS)	
F1.4 (Motion Band)	0 (1D) <input checked="" type="checkbox"/>	<i>Motion band.</i> Sets the level in display divisions at which scale motion is detected. If motion is not detected for 1 second or more, the “Stable” light is on. Some operations, including Zero, Tare and Print, require the scale to be at standstill. When F1.4 is selected OFF, F1.2 should also be set to OFF.
	1 (2D)	
	2 (3D)	
	3 (5D)	
	4 (10D)	
	5 (20D)	
6 (OFF)		
F1.5 (Overload)	0 (FS+2%)	<i>Overload.</i> Determines the point at which the display shows “OF” indicating the scale is overloaded.
	1 (FS+1D)	
	2 (FS+9D) <input checked="" type="checkbox"/>	
	3 (FS)	

F1.6 (Sample Rate)	0 (7.5Hz)	<i>Sample rate.</i> Selects the measurement rate in samples per second of the analogue-to-digital converter. Lower sample rate values provide greater signal noise immunity.
	1 (15Hz) ✓	
	2 (30Hz)	
	3 (60Hz)	
	4 (120Hz)	
	5 (240Hz)	
	6 (480Hz)	
	7 (960Hz)	
F1.7 (Digital Filter)	0	<i>Digital Filter.</i> Selects the digital filtering rate. The higher the value, the lower is the effects of motion impact the indicator. This results in having a more accurate display. However, it slows down the settling rate of the indicator.
	1 ✓	
	2	
	3	
	4	
	5	
	6	
	7	
F1.8 (Power Up Auto Zero for 805TS-B-17, 805BS-B-17 & 805BS-TN-B)	0 (Yes) ✓	<i>Power Up Auto Zero.</i> Specifies to automatically zero the scale when switching on the scale. When selected 0 (Yes), indicator zeros the scale after finishing self checking.
	1 (No)	
F1.9 (Power Up Manual Zero for 805TS-B-17, 805BS-B-17 & 805BS-TN-B)	0 (Yes) ✓	<i>Power Up Manual Zero.</i> Specifies to restore manually zero the scale when switching it on. When 0 (Yes) is selected, press zero button in the indicator to zero the scale and saves current zero for next powering up.
	1 (No)	

Note: Parameters that are in check are the default parameter values.

9.2.2 F2 (Format) Menu

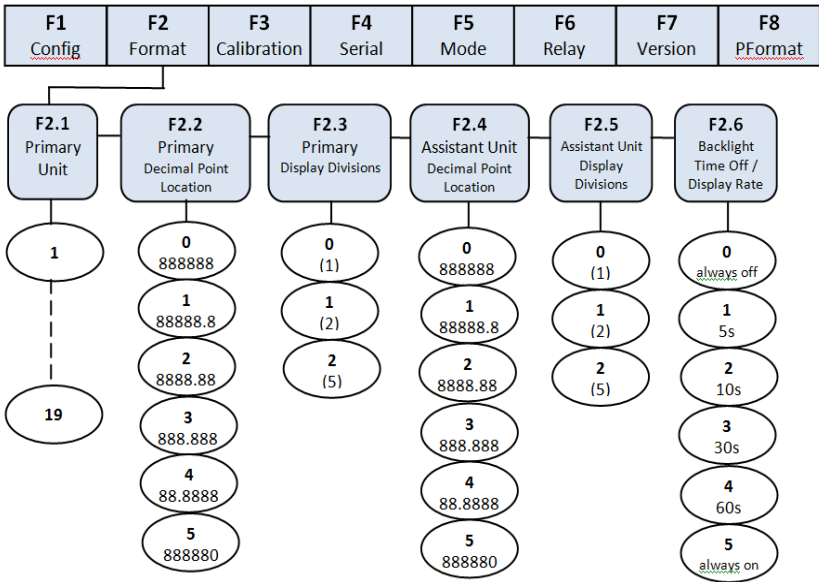

Fig. 9.2.2.1 F2 (Format) Menu

Table 9.2.2 F2(Format) Menu

F2 (Format) Menu			
Parameter	Choices		Description
Level 2 Submenu			
	805TS series	805BS series	
F2.1 (Primary Unit)	0 (<i>lb</i>)	0 v (P=kg, A=lb)	Specifies the unit used of the Primary unit. Note : P stands as Primary Unit while A as Assistant Unit
	1 (<i>kg</i>) v	1 (P=kg, A=g)	
	N/A	2 (P=kg, A=oz)	
		3 (P=kg, A=lb:oz)	
		4 (P=lb, A=kg)	
		5 (P=lb, A=g)	

	N/A	6 (P=lb, A=kg)	
		7 (P=lb, A=lb:oz)	
		8 (P=g, A=kg)	
		9 (P=g, A=lb)	
		10 (P=g, A=oz)	
		11 (P=g, A=lb:oz)	
		12 (P=oz, A=kg)	
		13 (P=oz, A=lb)	
		14 (P=oz, A=g)	
		15 (P=oz, A=lb:oz)	
		16 (P=lb:oz, A=kg)	
		17 (P=lb:oz, A=lb)	
		18 (P= lb:oz, A=g)	
		19 (P=lb:oz, A=oz)	
F2.2 (Primary Unit Decimal Point)	0 (888888)	Specifies the decimal position of the Primary unit. Note: If F2.4=5, and on during calibration in step F3.2 to edit the test weight value, you can	
	1 (88888.8) √		
	2 (8888.88)		
	3 (888.888)		
	4 (88.8888)		

Location)	5 (888880)		only edit the number on the left-hand of the flashing cursor, e.g. if you want to edit the tens place, the cursor must be flashing on the ones place, and you couldn't edit the ones place. When a decimal point has been changed, you must re-enter F1.1 and recalibrate (see section 9.2.3).
F2.3 (Primary Unit Display Divisions)	0 (1) ✓		Specifies the display divisions of the Primary unit.
	1 (2)		
	2 (5)		
F2.4 (Assistant Unit Decimal Point location)	0 (888888) ✓		Specifies the decimal position of the Assistant unit. When F6.1 is set to 0 or 2, the decimal position of the Assistant unit is defined by the decimal position of the Primary unit. Only when F6.1 is set to 1 or 3, the decimal position of the Assistant unit could be set as F2.4 defined.
	1 (88888.8)		
	2 (8888.88)		
	3 (888.888)		
	4 (88.8888)		
	5 (888880)		
F2.5 (Assistant Unit Display Divisions)	0 (1) ✓		Specifies the displayed divisions of the Assistant unit.
	1 (2)		
	2 (5)		
F2.6 (Backlight Time Off for 805BS models) <i>Not available in 805BS-TN-B)</i>	805TS & 805BS-TN-B	805BS-B-17 & 805BS-B-H	-Sets the time to off/dim the backlight display for 805BS-B-17 except for 805BS-TN-B -The update rate for both 805TS and 805BS is 20ms or 50Hz.
	N/A	0 (always off)	
		1 (5s)	
		2 (10s) ✓	
		3 (30s)	
		4 (60s)	
5 (always on)			

Note :

1. When selecting F6.1=0 (NTEP) or F6.1=2 (Canada), Assistant Unit Decimal Point Location and Assistant Unit Display Divisions will change automatically according to the Primary Unit Decimal Point Location and Primary Unit Display Divisions (refer to F6.1 Menu).
2. Parameters that are in check are the default parameter values.

9.2.3 F3 (Calibration) Menu

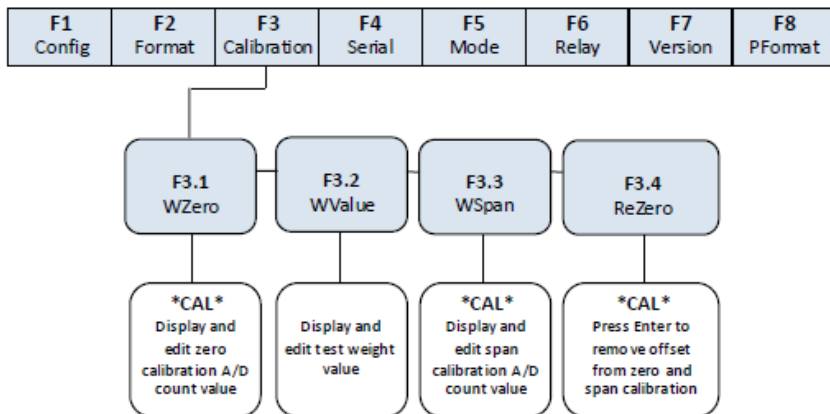

Fig. 9.2.3.1 F3 (Calibration) Menu

Table 9.2.3 F3(Calibration) Menu

F3 (Format) Menu		
Parameter	Choices	Description
Level 2 Submenu		
F3.1 (WZero)	—	Display and edit the zero calibration A/D count value. Do not adjust this value after F3.3 (WValue) has been set. Refer to Section 10.
F3.2 (WValue)	—	Display and edit the test weight value, the value entered must above 100. Refer to Section 10.

<p>F3.3 (WSpan)</p>	<p>—</p>	<p>Display and edit the span calibration A/D count value. If re-zero isn't needed, press ▲ to exit, leap over F3.4. Refer to Section 10.</p>
<p>F3.4 (REZero)</p>	<p>—</p>	<p>Press ○ to remove an offset value from the zero and span calibration. Use this parameter only after F3.1 (WZero) and F3.3 (WSpan) have been set. Refer to Section 10.</p>

9.2.4 F4 (Serial Interface) Menu

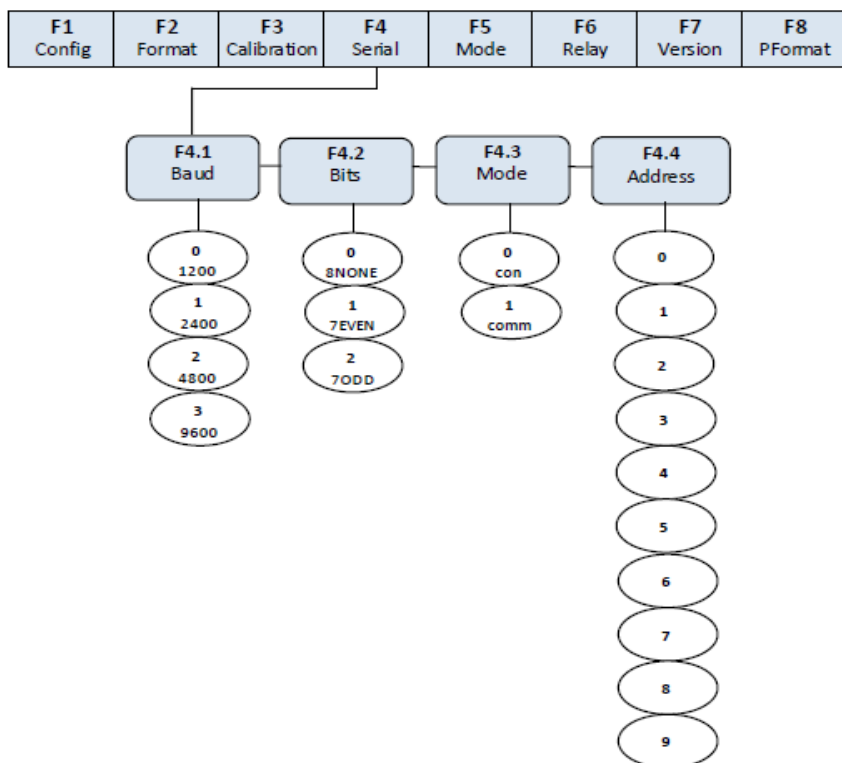

Fig. 9.2.4.1 F4(Serial) Menu

Table 9.2.4 F4 (Serial) Menu

F4 (Format) Menu		
Parameter	Choices	Description
Level 2 Submenu		
F4.1 (Baud)	0 (1200)	Specifies settings for baud rate.
	1 (2400)	
	2 (4800)	
	3 (9600) ✓	
F4.2 (Bits)	0 (NONE) ✓	Specifies settings for the number of data bits.
	1 (7EVEN)	
	2 (7ODD)	
F4.3 (Mode)	0 (con)	Selects the mode of data transmission. 0(con) is for continuous transmission and 1(comm) is for transmission upon receiving commands. It must be set to 1 to use print function. Refer to Section 14.
	1 (comm) ✓	
F4.4 (Address)	0 ✓	Select address of serial port.
	1	
	2	
	3	
	4	
	5	
	6	
	7	
	8	
9		

9.2.5 F5 (Mode) Menu

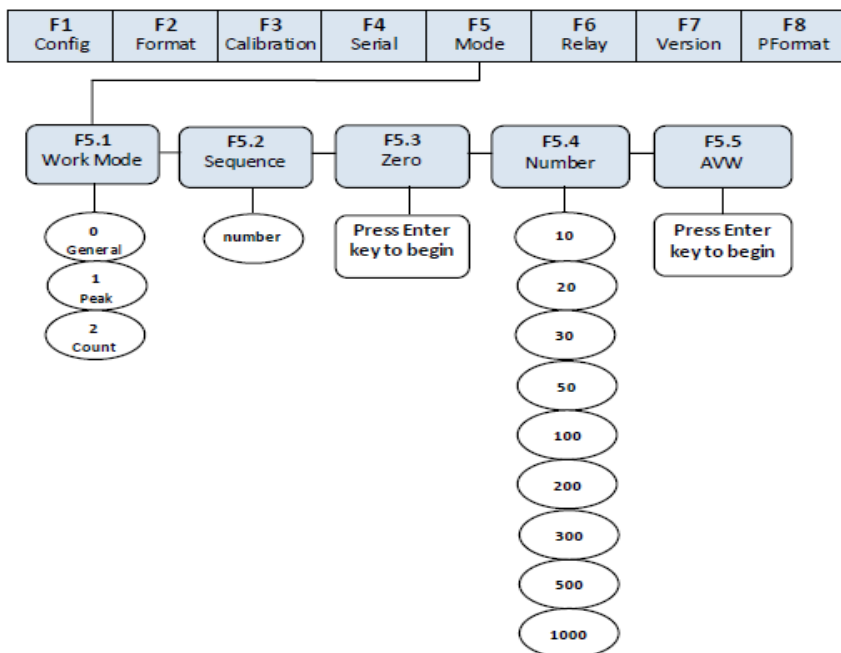

Fig. 9.2.5.1 F5(Mode) Menu

Table 9.2.5 F5(Mode) Menu

F5 (Mode) Menu		
Parameter	Choices	Description
Level 2 Submenu		
F5.1 (Work Mode)	0 (General) ✓	Selects one of the three operation modes. Refer to Section 7 for descriptions of three different operation modes. If you want to select Peak and Counter Mode, F6.1 must be set to 3(NONE), otherwise, Peak and Counter Mode won't be functional.
	1 (Peak)	
	2 (Counter)	
F5.2 (Counted Item Code)	number	Specifies the item code number of counted items. Allowable numbers are 0 to 99. Refer to Section 11 for description of the setting of the counted item code.

F5.3 (Zero)	—	Sets the scale to zero before inputting the average weight of counted items. Refer to Section 5.
F5.4 (Sampling Quantity)	10 √	Specifies the quantity of sample counted items. Refer to Section 11.
	20	
	30	
	50	
	100	
	200	
	300	
	500	
1000		
F5.5 (Average Weight)	—	Displays and edits the average weight of the counted items. Refer to Section 11.

9.2.6 F6 (Relay) Menu

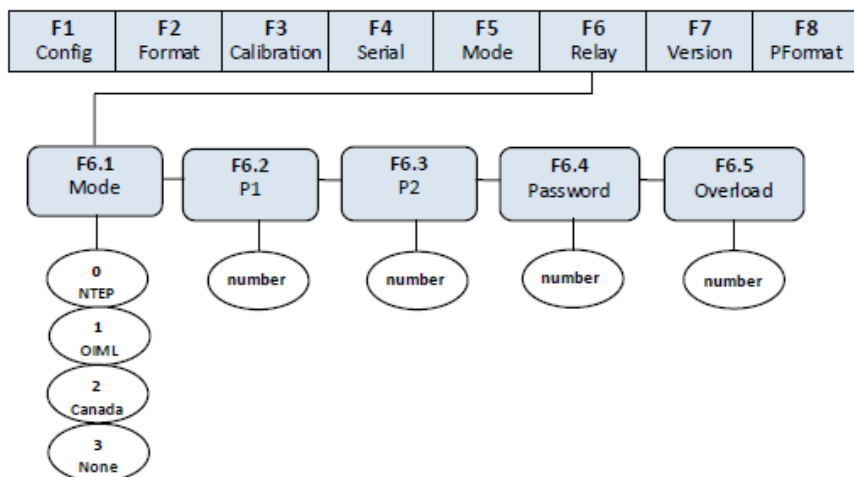

Fig. 9.2.6.1 F6(Relay) Menu

Table 9.2.6 F6(Relay) Menu

F6 (Relay) Menu		
Parameter	Choices	Description
Level 2 Submenu		
F6.1 (mode)	0 (NTEP) √	For OIML, NTEP and CANADA application, Tare removal is only allowed when Gross = 0. When
	1 (OIML)	
	2 (CANADA)	

	3 (NONE)	<p>NONE is selected, Tare removal can be done at any weighing mode.</p> <p>For NTEP and OIML, a new Tare can be acquired even when there is a stored Tare.</p> <p>For CANADA, a new Tare can be acquired after the stored Tare is removed.</p> <p>For NONE, NTEP and CANADA, when the current weight is within the specified zero range, zero scale can be performed irrespective it is in Gross or Net mode.</p> <p>For OIML, zero scale can only be performed when it is in Gross mode and Tare can be removed when it is in Net mode.</p>
<p>F6.2 (P1)</p> <p><i>This function is not available in 805BS-TN-B Lite Version model</i></p>	Number	Specifies fixed value 1. Refer to Section 12 for Relay Output setup.
<p>F6.3 (P2)</p> <p><i>This function is not available in 805BS-TN-B Lite Version model</i></p>	Number	Specifies fixed value 2. Refer to Section 12 for Relay Output setup
<p>F6.4 (Password)</p> <p><i>For 805TS-B-17, 805BS-B-17 & 805BS-TN-B</i></p>	Number	The password is required when entering or exiting configuration mode. (refer to Section 15.2.3)
<p>F6.5 (User Overload)</p> <p><i>For 805TS-B-17, 805BS-B-17 & 805BS-TN-B</i></p>	Number	When net weight exceeds user overload value, alarm will start beeping.

Note: If F6.4 = 0 & F6.1 = 3 (none), SW2 switch is still used to enter and exit calibration menu. If F6.4 > 0 & F6.1 = 3 (none) and SW2 switch is ON, password is required for entering and exiting calibration menu.

9.2.7 F7 (Version) Menu

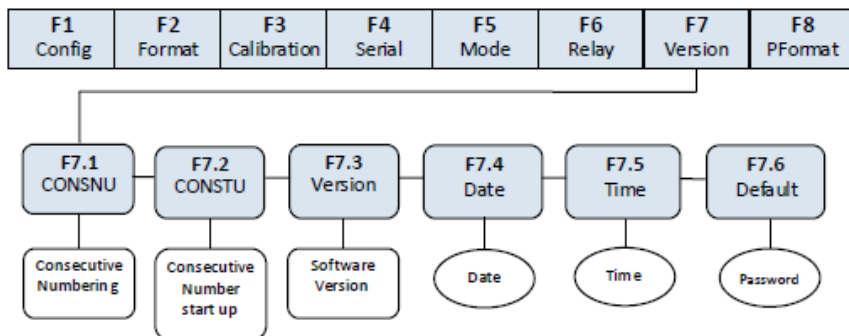



Fig. 9.2.7.1 F7(Ver) Menu

Table 9.2.7 F7(Ver) Menu

F7 (Ver) Menu		
Parameter	Choices	Description
Level 2 Submenu		
F7.1 (CONSNU)	Number	Consecutive Numbering. Allows sequential numbering for print operations. The consecutive number value is incremented following each print operation. The initial value of this parameter is set to the start up value specified on the CONSTU (F7.2 value). Refer to Section 13.4
F7.2 (CONSTU)	Number	Consecutive Number Start Up Value. Refer to Section 13.4
F7.3 (Version)	Soft Version	Displays the software version installed in the indicator. This value cannot be altered.
F7.4 (DATE)	Date	Format setting for the date is: "DD.MM.YY"
F7.5 (TIME)	Time	Setting of time as "HH.MM.SS"

<p>F7.6 (Default)</p>	<p>Number</p>	<p>Press  after inputting the password to recover the default value in the ROM. Refer to Appendix 9-2.</p>
---------------------------	---------------	---

9.2.8 F8 (PFormat) Menu

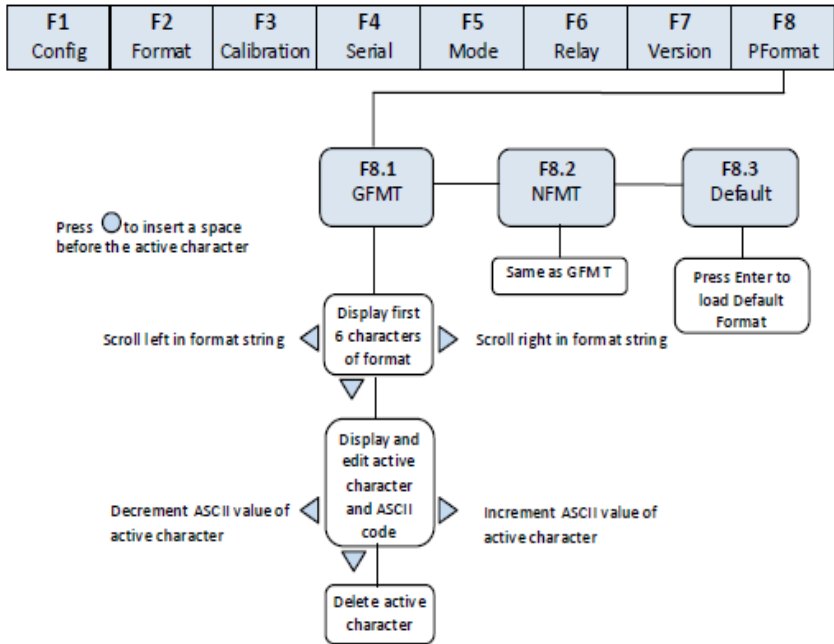

Fig. 9.2.8.1 F8 (PFormat) Menu

F8 (PFormat) Menu is used for setting Print format of serial print output. Refer to Section 13.

10. Calibration

The calibration of these indicators consists of the following calibration procedures:

- Zero calibration
- Providing the test weight or known weight and its weight value
- Span calibration

- Re-zero calibration (applicable if test weights are used with hooks or chains)

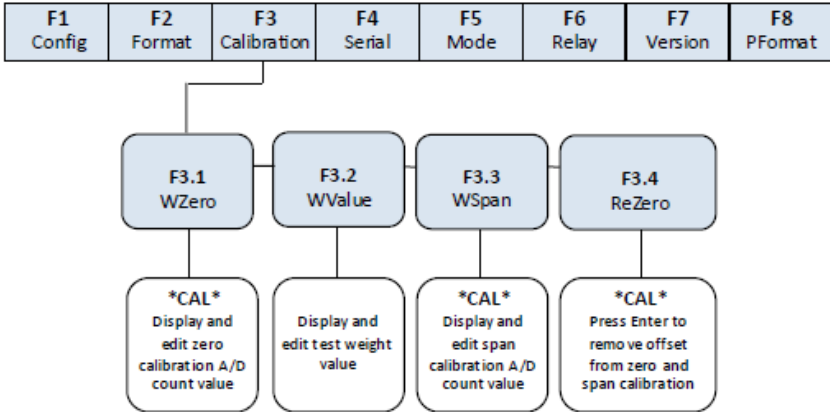

Fig. 10.1 F3(Calibration) Menu









This section describes calibration procedures for each of the calibration methods. There are two methods in calibrating the indicator:

1. **Weight Calibration** – this method will require an actual test weights or known weight to calibrate the scale and indicator
2. **Digit Calibration** – in this method the actual test weight may not be required. It requires the A/D Count for the zero, span and re-zero calibration. This method can be applicable only if you had already successfully done the Weight Calibration and recorded its A/D Count in each procedure. You may not required to load the actual test weights in the scale for the span calibration.



Weight Calibration Procedures:

Suggestion: In conducting the Weight Calibration procedures it is recommended to record all the A/D count values generated by the indicator and the test weight value from F3.1, F3.2, F3.3 and F3.4. When certain parameters were accidentally altered, the data can be recovered by following the Digit Calibration procedures. There is no need to re-calibrate using the actual test weights.

- 1) Turn on the SW2 switch to set indicator to the Configuration mode (display shows “F1”). Remove all weights from the scale platform. If the test weights require hooks or chains, place the hooks or chains on the scale for zero calibration.

- 2) Press  until the display shows "F3" (see Fig. 10.2). Press  to go to zero calibration mode. Display shows "F3.1".
- 3) When display shows "F3.1", press  to zero calibrate the indicator. Display will show "CAL" while calibration is in progress. When completed, the A/D count for the zero calibration is shown. You may record this A/D count. This A/D count (usually a 6-digit count) can be used if recalibrating the indicator using the Digit Calibration Method. Do not adjust this value. Then press  again to save the zero calibration value and go to the next menu (display shows "F3.2").
- 4) When display shows "F3.2", place test weight on the scale and press  to show the test weight value. Follow Fig. 10.2 to input the test weight value, then press  to save the value and go to the next menu. Display shows "F3.3".
- 5) When display shows "F3.3", press  to span calibrate. Display shows "CAL" while calibration is in progress. When completed, the A/D count for the span calibration is shown. You may record this A/D count. This A/D count (usually a 6-digit count) can be used if recalibrating the indicator using the Digit Calibration Method. Do not adjust this value. Press  again to save the span calibration value and go to the next menu. Display shows "F 3.4".
- 6) F3.4 Menu is used to remove a calibration offset when hooks or chains are used to hang the test weights.









When display shows "F3.4", there are 2 options:

- If no other apparatus are used to hang the test weights during calibration, remove the test weight and press  to return to F4 Menu. Display shows "F4"
- If hooks or chains are used during calibration, remove these and the test weights from the scale. With all weight removed, press  to re-zero the scale. This function adjusts the zero and span calibration values. Display shows "CAL" while zero and span calibrations are adjusted. When completed, the adjusted A/D count for the zero calibration is shown. You may record this A/D count. This A/D count (usually a 6-digit count) can be used if recalibrating the indicator using the Digit Calibration Method. Do not adjust this value. Press  to save the value and to return to



F4 Menu. Display shows “F4”.

- 7) Turn off the SW2 switch to exit from Calibration mode and enter into Weighing Mode.

Digit Calibration Procedures:

- 1) Turn on the SW2 switch to set indicator to the Configuration mode (display shows “F1”). Remove all weights from the scale platform. If the test weights require hooks or chains, place the hooks or chains on the scale for zero calibration.
- 2) Press  until the display shows “F3” (see Fig. 10.2). Press  to go to zero calibration mode. Display shows “F3.1”.
- 3) When display shows “F3.1”, press , display shows the A/D count of the original or previous zero calibration. Modify and enter the A/D count 6-digit value for your recorded zero calibration. When done, press  to save and to go to the next menu. Display shows “F3.2”.
- 4) When display shows “F3.2”, in this stage test weigh may not be required, press  to show the test weight value. Enter the test weight value based on your recorded calibration settings, then press  to save the value and go to the next menu. Display shows “F3.3”.
- 5) When display shows “F3.3”, press  to show the A/D count of the original or previous span calibration. Modify and enter the A/D count 6-digit value for your recorded span calibration. When done, press  to save and to go to the next menu. Display shows “F3.4”.
- 6) F 3.4 Menu is used to remove a calibration offset when hooks or chains are used to hang the test weights.

When display shows “F3.4”, there are 2 options:

- If no other apparatus is used to hang the test weights during calibration, remove the test weight and press  to return to F4 Menu. Display shows “F4”
- If hooks or chains are used during calibration, you may not remove these and the test weights from the scale. Press  to show the A/D count of the original or previous re-zero calibration. Modify and enter the A/D count 6-digit value for your recorded re-zero calibration. When done, press  to save the value and to return to F4 Menu. Display shows “F4”.

- 7) Turn off the SW2 switch to exit from Calibration mode and enter into Weighing Mode.

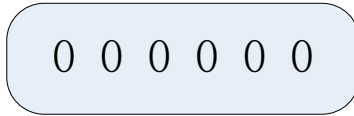

Fig. 10.2 Editing Procedure for Numerical Values

When editing numerical values, press , to change the digit selected. Press , to increase or decrease the value of the selected digit.

11. Count Items Average Weight Setup

When Count mode is activated in F5.1 Menu, it is required to set up the average weight of the count items. The indicator can be set up for up to 100 count items. The count items setup consists of the following procedures:

- o Item code
- o Zero scale
- o Sample quantity
- o Confirming Count Items Average Weight

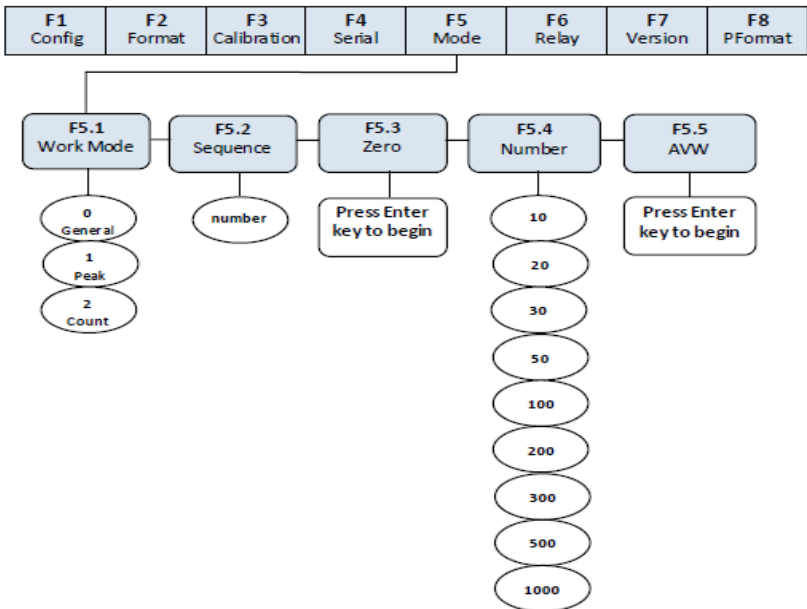

















Fig. 11.1 Count Items Average Weight Setup Menu

Setup procedures are as follows:

- (1) Turn on the SW2 switch to set indicator to the Configuration mode (display shows "F1").
- (2) Press  until display shows "F5" (see Fig 11.1). Press  and the display will show "F5.1". Press  then press  until F5.1 = 2. Next press  to save the value. Once the value is saved, "F5.2" is displayed.
- (3) Press  when display shows "F5.2". Display shows and asks a code number for your count items average weight settings. The code number will be saved in the memory and represents the code for your count items average weight settings. The code numbers are from 01 to 99. The code "00" is reserved for Fast Setup of Count Items Average Weight (refer to Section 7.3.8). Follow the procedure in Fig. 10.2 to input and edit the code number. Press  to save the code number and proceed to the next menu. The display shows "F5.3".
- (4) Remove all the weight from the scale platform when display shows "F5.3". Press  to zero the scale. Display shows "CAL" while processing the zeroing operation. When completed, display shows "F5.4"
- (5) Press  when display shows "F5.4". Display shows the sampling quantity of the count items. Use ,  keys to specify the sampling quantity. Place the samples in the platform of the scale. The quantity of the samples must be the same with what you specified in the sampling quantity. Press  to proceed to the next menu. Display shows "F5.5".
- (6) Press  when display shows "F5.5". Display shows "CAL" while processing the average weight setting. When completed, there are two (2) possible outcomes :
 - The average weight is too small and display shows "—E5—". Press  to return to F5.5 Menu and display shows "F5.5". There are two options :
 - Combine a few small items as one sample. Place the same sampling quantity as specified in F5.4 Menu. Press  to

perform the average weight calculation.

- Press \triangle to cancel average weight setting and return to F5 Menu. Display shows “F5”.
 - When the average weight is completed the display will return to the F5.2 Menu and display shows “F5.2”
- (7) There are 2 options when display shows “F5.2”.
- Repeat (3) to (6) if you want to set and save another count items average weight settings.
 - Press \triangle to return to F5 Menu if no more average weight setting is required. Display shows “F5”.
- (8) Turn off the SW2 switch to exit from Calibration mode and enter into Weighing Mode.
- (9) In the Weighing Mode, press **【PRINT】** to go to Input Item Code status. Enter the code number that corresponds to your count items average weight settings you had been stored in the indicator. The code “00” will return the indicator to “Fast Setup of Count Items Average Weight” (refer to Section 7.3.8). Press **【UNITS】** in switching from Count Mode to Weighing Mode.

12. Relay Output Setup

There are two relay signal outputs in the Relay function. When the weight value is smaller than the weight value setting in F6.2, the Relay output 1 is switched on or shorted and Relay output 2 is switched off or opened. When the weight value is between the weight value setting in F6.2 and F6.3, both relay outputs are switched off or opened. When weight value is greater than the weight value setting in F6.3, the Relay output 2 is switched on or shorted while the Relay output 1 is off or opened. See Fig. 12.2 for more details.

Setup procedure:

- (1) Turn on the SW2 switch to set indicator to the Configuration mode (display shows “F1”).
- (2) Press \triangleright until display shows “F6” (see Fig. 12.1). Press ∇ to go to the Relay Output Menu. Display shows “F6.1”.
- (3) When the display shows “F6.1”, press \triangleright to go to the F6.2 Menu and display shows “F6.2”.

- (4) When display shows “F6.2”, press ▼ and display shows the value of Relay 1 setting. Edit Relay value according to editing procedures in Fig. 10.2. When completed, press ○ to store the value and return to F6.3 Menu. Display shows “F6.3”.
- (5) When display shows “F6.3”, press ▼ and display shows the value of Relay 2 setting. Edit Relay value according to Fig. 10.2. When completed, press ○ to store the value and return to F6.1 Menu. Display shows “F6.1”.
- (6) Turn off the SW2 switch to exit from Calibration mode and enter into Weighing Mode.

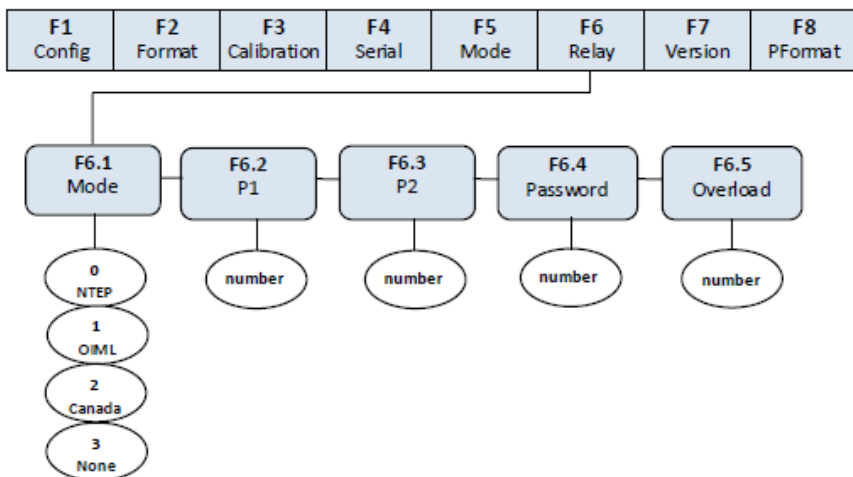

Fig. 12.1 Relay Output Menu

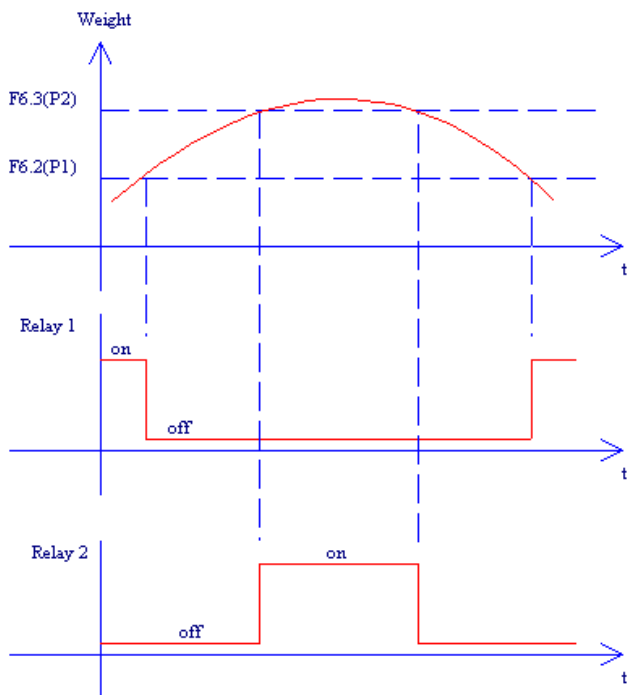

Fig. 12.2 Relay Output-Upper and Lower Values

Note 1: Must ensure F6.3 (P2) value > F6.2 (P1) value to give proper relay outputs
Note 2: Weight value is in net weight and is according to the unit in F2.1 setting (Refer to F2 Menu in Section 9.2.2).

13. Print Format

2 print formats via the serial port output

- Gross weight print format
- Net weight print format

After confirming print format GFMT and NMFT, press **【PRINT】** for printing operation.

When the gross weight stored is something other than 0, use NFMT format. In other cases, use GFMT format.

13.1 Print Format Commands

Print format commands are as shown in Table 13.1. Command included in the format strings must be enclosed between < > delimiters. Any characters outside of the delimiters are printed as text on the ticket. Text characters can include any ASCII character shown in Appendices. The maximum number of characters that can be input into each print format is 250.

Table 13.1 Print Format Commands

Command	Description
<G>	Gross weight in displayed units. The format is "XXXXXXX UU" where "XXXXXXX" is the weight and "UU" is the unit
<N>	Net weight in displayed units. Same format as in <G> command
<T>	Tare weight in displayed units. Same format as in <G> command.
<CN>	Consecutive number. The Format is "XXXXXX". See Section 13.1. For print consecutive number setting.
<CD>	Count item code (must set count code first). The format is "XX". See Section 7.3.6 for count item code setting.
<CO>	Count item quantity (must set count quantity first). The format is "XXXXX".
<D>	Date of printing. Format: dd-mm-yy, where dd is the day, mm is the month and yy is the year.
<I>	Time of printing. Format: HH:MM:SS, where HH is the hour, MM is the minute and SS is the second.
<P>	Peak mode value (used only when Peak Mode is set). The format is "XXXXXXX" (including decimal point)
<NLnn>	New line (nn is the number for CR and LF. Value must be in the range 1-99. If nn is not specified, 1 is assumed).
<SPnn>	Space (nn=number of space. Value must be in the range 1-99. If nn is not specified, 1 is assumed).
<E>	Command to complete print format setting. If a command is not ended with the <E> command, indicator is operated without print mode.

When indicator is set to Default Format String, use Table 13.2 for the default print format.

Table 13.2 Default Print Format

Format	Default Format String	Sample Output
GFMT	<G>GROSS<NL>	1564.23 LB GROSS
NFMT	<G>GROSS<NL> <T>TARE<NL> <N>NET<NL>	4567.2 LB GROSS 23.5 LB TARE 4543.7 LB NET

13.2 GFMT and NFMT Print Format Input

Setting of GFMT and NFMT is as follows:

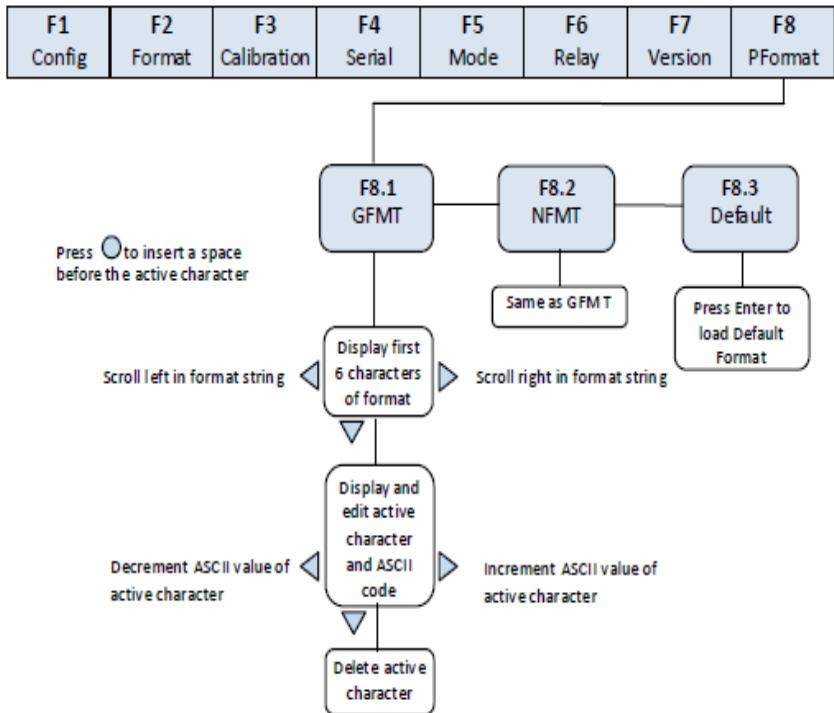























Fig. 13.2.1 Print Format Input Flow Diagram

- (1) Turn on the SW2 switch to set indicator to the Configuration mode (display shows “F1”)
- (2) Press  to show “F8” (see Fig. 13.2.1). Press  to Print Format Menu and display shows “F 8.1”.
- (3) When display shows “F8.1”, press  again and display shows the first 6 digits of GFMT format.
- (4) Use ,  to move the cursor to different flashing digits. When it is at the far right position, press  again, the first digit at the left is removed and another digit prompts up at the right. When it is at the far left position, press , the last digit at the right is removed and another digit prompts up at the left. Press  to add a space to the left of the flashing digit.
- (5) When the cursor is at a certain digit position, press  to edit. Display shows the characters as shown in Appendix 15.5. “_.” is shown for characters not available in Appendix 15.5.
- (6) While editing, use ,  to move between characters. To delete a character from the string press . Once deleted the indicator will return to F8.1.
- (7) When character editing is completed, press  to return to (4) above and to perform editing other characters. When finish editing, press  to return to F8.1 and display shows “F8.1”.
- (8) Press  to go to F8.2 Menu and display shows “F8.2”. Refer to (3) to (7) for format editing of NFMT.
- (9) After finishing, turn off the SW2 switch to exit from Calibration mode and enter into Weighing Mode.

Note: When inputting characters, display shows characters as per Table 13.2. “_” is shown for unavailable characters.

13.3 Default Formatting

- (1) Turn on the SW2 switch to set indicator to the Configuration mode and display shows “F1”.

- (2) Press  until display shows “F8” (see Fig. 13.2.1). Press  to go to Print output menu and display shows “F8.1”.
- (3) When display shows “F8.1”, press  twice and display shows “F8.3”.
- (4) When display shows “F8.3”, press  to show “Set?”. There are 2 options then:
 - Press  to change GFMT and NFMT format characters to default value in Table 13.2, and then return to F8 Menu. Display shows “F8”.
 - Press  to give up restored default format operation and to return to F8 Menu. Display shows “F8”
- (5) Turn off the SW2 switch to exit from Calibration mode and enter into Weighing Mode.

13.4 Print Consecutive Number

Set print consecutive number in Print mode. F7.1 Menu (CONSNU) is the current consecutive number. The consecutive number value is increased by 1 following each print operation. When start up indicator, F7.2 is assigned as the initial consecutive number. F7.2 is used to set the initial consecutive number. Refer to F7.1 Menu and F7.2 Menu for details.

Detailed Setup Procedure:

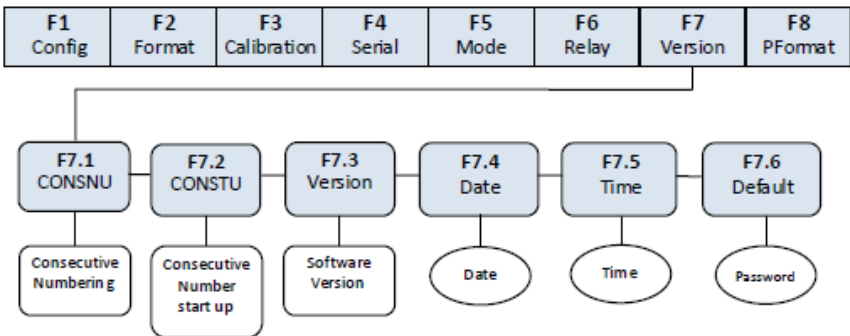













Fig. 13.4 Consecutive Numbering Setup

- (1) Turn on the SW2 switch to set indicator to the Configuration mode. Display shows "F1".
- (2) Press  until display shows "F7" (see Fig. 13.2.1). Press  to go to F7.1 Menu. Display shows "F7.1"
- (3) When display shows "F 7.1", press . Display shows the current consecutive number "nnnnn". Edit numbers according to Fig. 4-2.
- (4) After editing, press  to return to F7.2 Menu. Display shows "F7.2"
- (5) When display shows "F7.2", press . Display shows "nnnnn". Edit numbers according to Fig. 4-2.
- (6) After editing, press  to return to F7.3 Menu. Display shows "F7.3".
- (7) Turn off the SW2 switch to exit from Calibration mode and enter into Weighing Mode.

13.5 Date and Time Setting

- (1) Follow points (1) and (2) to enter into F7 Menu.

When display shows "F7.1", press  until display shows "F7.4" (see Fig. 13.4). Press  to enter into Date setup mode and display shows "DD.MM.YY".
- (3) When date setup is complete, press  to return to F7.5 Menu. Display shows "F7.5".
- (4) When display shows "F7.5", press  and display shows time "HH.MM.SS". Follow Fig. 4-2 to set the current time.
- (5) When complete, press  to return to F7.6 Menu. Display shows "F7.6".
- (6) Turn off the SW2 switch to exit from Calibration mode and enter into Weighing Mode.

14. Serial Communication

Indicator has the following two serial communication modes:

- Continuous transmission
- Transmission upon request (from an external PC)

Set up Baud, Bits, Parity, Mode and Test in F4 Menu.

Detailed Setup Procedure is as follows:

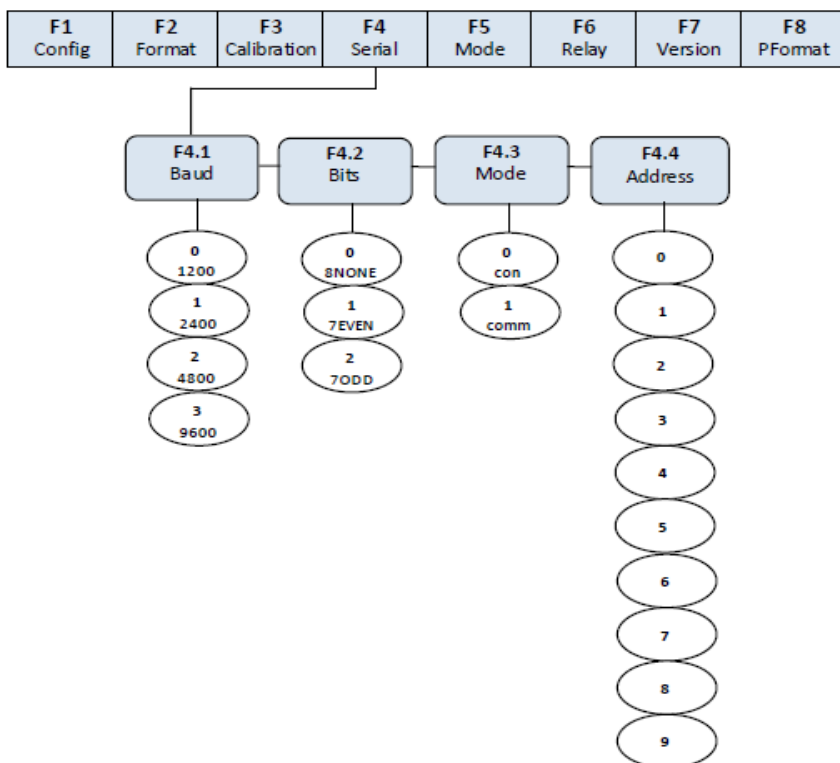

Fig. 14.1 Serial Communication Menu

14.1 Continuous Transmission

- (1) Turn on the SW2 switch to set indicator to the Configuration mode.
Display shows "F1"
- (2) Press ▶ until display shows "F4" (see Fig. 8-1). Press ▼ to go to F4 Menu. Display shows "F4.1".
- (3) When display shows "F4.1", press ▶ until display shows "F4.4".
- (4) When display shows "F4.4", press ▼ to show serial

communication code. Use \blacktriangleright to set serial communication code to 0 (data transmitted continuously).

- (5) Turn off the SW2 switch to exit from Calibration mode and enter into Weighing Mode. After selecting continuous transmission mode (F4.4=0), indicator transmits data continuously according to Fig. 14.1.

Note: Other items in F4 Menu are for Baud, Bits Test and etc. Start and stop are set at 1. These parameters are suitable for continuous transmission and transmission upon request modes

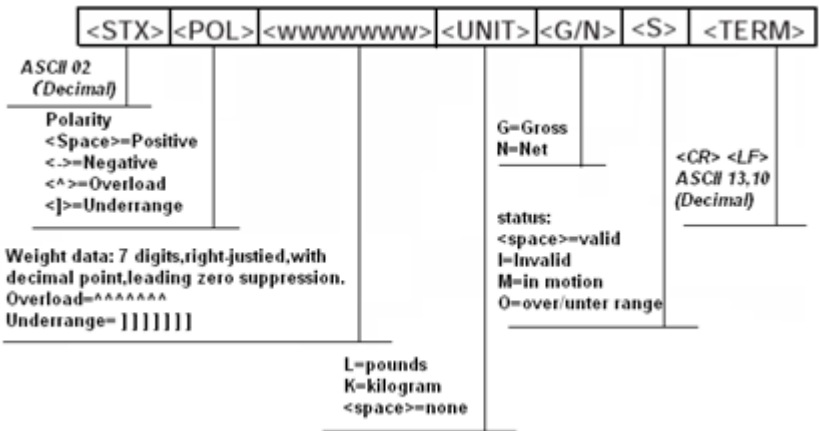

Fig. 14.1 Format of Continuous Transmission

14.2 Transmission Upon Request

Specify F4.4=1 as Section 14.1 above. After selecting the mode, indicator transmits data upon request according to Fig. 8-3 and Fig. 8-4. When receiving a command, the indicator sends “OK” after transmitting the requested data. The indicator sends “??” if it receives undefined or incorrect request or command

14.2.1 Data Transmission Sequence

Transmission Format from PC:

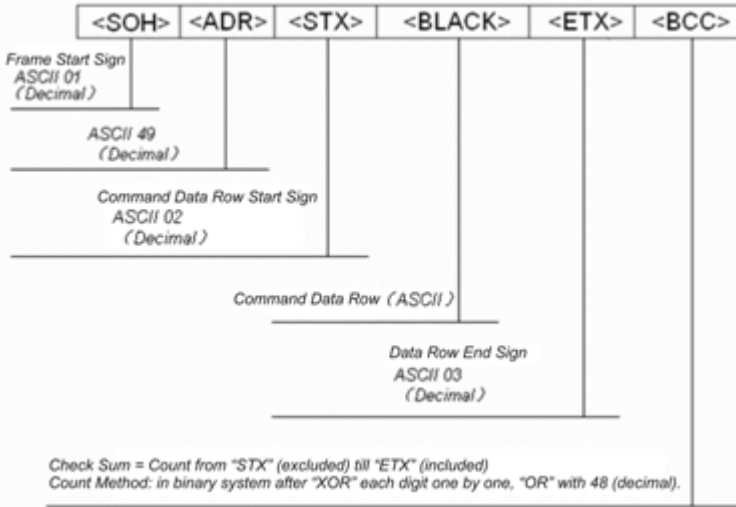

Fig. 14.2.1 Transmission Format from PC

Example: Set BLACK to "G" (which is 47H) in ASCII code. Inspection and BCC calculation are as follow:

ASCII	HEX	BCC	
G	47H	47H	
ETX	03H	44H	
	30H	74H	"OR" with 30H

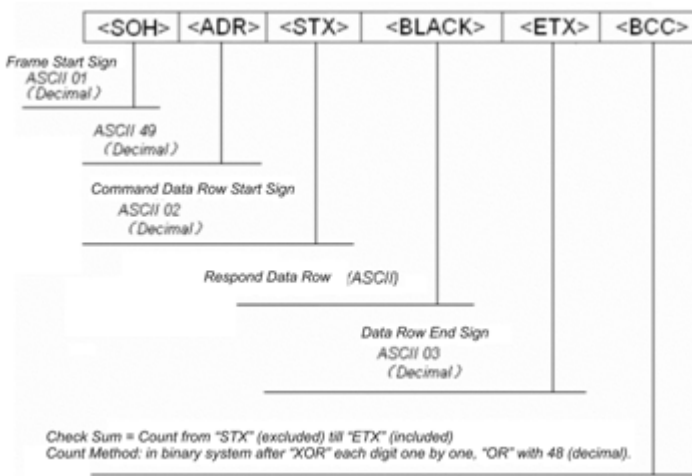

Fig. 14.2.2 Respond Format from Indicator

14.2.2 Communication Command

14.2.2.1 Transmit Current Weight Value

Command data from PC<BLACK> Format: G (ASCII 71)

Response data from indicator<BLACK> Format see Fig. 14.2.2.1

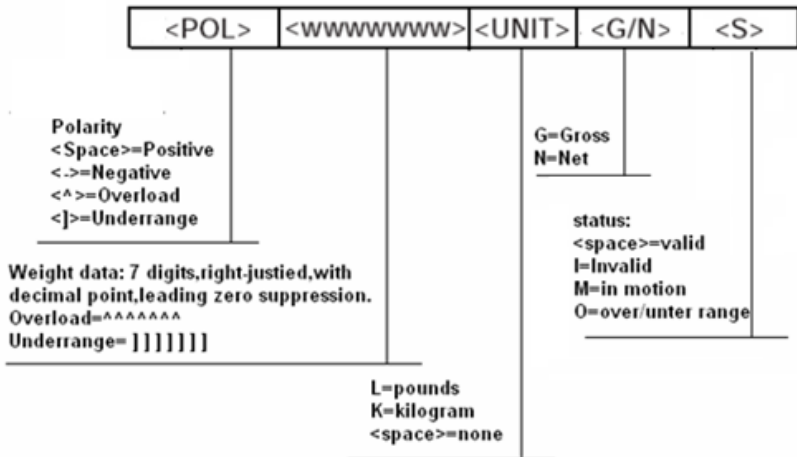

Fig. 14.2.2.1 Respond to<BLACK>data after receiving G command

Example: PC receives data from indicator

PC sends: 01H, 31H, 02H, **47H**, 03H, 74H

Indicator responds: 01H, 31H, 02H, **20H, 20H, 20H, 20H, 31H, 30H, 37H, 32H, 4BH, 47H, 20H**, 03H, 3BH

Data received in gross weight 1072kg。

14.2.2.2 Zero Scale

PC command data <BLACK> format: Z (ASCII 90)

Indicator receives correctly and responds data <BLACK> =“OK”

Example: PC sends command to indicator to zero scale

PC sends: 01H, 31H, 02H, **5AH**, 03H, 79H

Indicator responds: 01H, 31H, 02H, **4FH, 4BH**, 03H, 37H

15. Appendices

15.1 Error Messages

Error Message	Description	Solution
-- E 0 --	Data too big after changing units	Check decimal setting in primary and secondary units. Refer Section 9.2.2 regarding F2 Menu
-- E 1 --	Incorrect operating parameters	Check parameters according to Section 9
-- E 2 --	A/D exchange error S	Check hardware by qualified personnel
-- E 3 --	Data reading error	Check hardware by qualified personnel
-- E 4 --	A/D transfer start up error	Check hardware by qualified personnel
-- E 5 --	Count item average weight too small	Check scale range or increase sampling weight according to Section 11
-- E 6 --	No average weight set for count items	Refer to Section 11 to set average weight
-- E 7 --	Load cell input signal > 20mV	Check load cell and connecting cables
-- EL --	Load cell input signal < -4mV	Check load cell and connecting cables
-- OF --	Load value > F1.5 Set value	Reduce load on scale

15.2 Software Version and Default Configuration Parameters

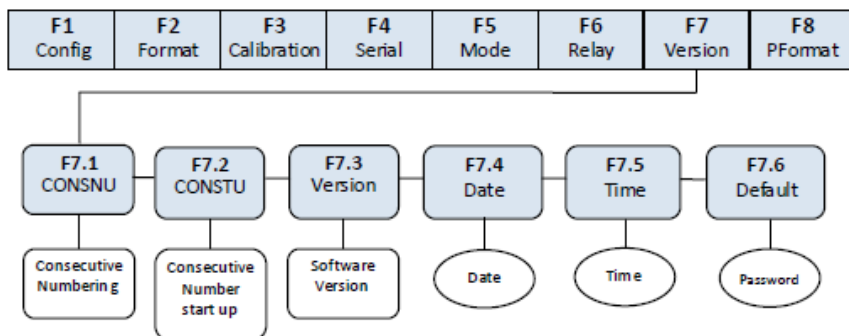















Fig. 15.2.1 F7(Ver) Menu

15.2.1 Find out indicator software version

- (1) Turn on the SW2 switch to set indicator to the Configuration mode. Display shows "F1".
- (2) Press  until display shows "F7" (see Fig. 15.2.1). Press  to go to F7 Menu. Display shows "F 7.1". Press  twice until display shows "F7.3".
- (3) When indicator shows "F7.3", press  again, display shows the current software version "XX.XX". Software version cannot be edited.
- (4) Press  to return to F7.3 Menu. Display shows "F7.3".
- (5) Turn off the SW2 switch to exit from Calibration mode and enter into Weighing Mode.

15.2.2 Restore Factory Setup Parameters (Default Configuration Parameters)

- (1) Turn on the SW2 switch to set indicator to the Configuration mode. Display shows "F1".
- (2) Press  until display shows "F7" (see Fig. 15.2.1). Press  to show "F7.1". Press  until display shows "F7.6".
- (3) When display shows "F7.6", press . Display shows a 4 digit code "=="0000". Edit it to "0711" according to Fig. 10.2. Press .
- (4) There are 2 possible outcomes:
 - If input code is correct, display shows "Set?" Then there are 2 options:
 - Press  to restore parameters to factory setup and return to F7.6 Menu. Display shows "F7.6".
 - Press , give up restoring factory setup and return to F7.6 Menu. Display shows "F7.6".
 - If input code is incorrect, display shows "Err". Then there are 2 options:
 - Press , display shows a 4 digit code "=="0000".

Return to step (3) above and re-enter the code.

- Press , give up restoring factory setup and return to F7.6 Menu. Display shows “F7.6”.
- (5) When indicator shows “F7.6”, turn off the SW2 switch to exit from Calibration mode and enter into Weighing Mode.

15.2.3 Enable the Password Function (Entering or exiting Configuration Mode)

The password function is a feature in which the user will enter the password to switch the indicator from Weighing Mode to Configuration Mode or vice versa without opening the back panel of the indicator. This feature is only applicable if legal-for-trade is not required like NTEP, OIML & Measurement Canada

- (1) To enable the password function the parameter settings in F6.1=3 (NONE) and F6.4>0.
- (2) Open the back panel and put the indicator in Configuration mode by switching the K1 jumper switch into CFG
- (3) Go to F6.1 menu and set the value to 3 then accept. Skip to F6.4 and enter your desired password. The display shows P00000. The password should not equal to 00000. For example if you want your password to be “11111”, edit the F6.4 to P11111 then accept by pressing the tare key. Switch back the K1 jumper to DFT and check the display if the indicator is switched to weighing mode. Once the indicator is in weighing mode, switch back again the K1 switch to CFG and check the indicator should still be in weighing mode. The password is enabled. Re-install the back panel.
- (4) To enter the Configuration mode, long press the TARE key until password interface pops up. The display shows P00000. Enter your password and press tare key. The display should display F1 meaning you are in the Config Mode.
- (5) To exit the Configuration mode, long press the TARE key until password interface pops up. The display shows P00000. Enter your password and press tare key. The indicator should return to Weighing mode.
- (6) To deactivate the password, go to Configuration mode and set the F6.4 to “00000”. Press tare key to accept the changes.

15.3 Technical Specifications

Specifications	805TS Series		805BS Series	
	805TS-B-17		805BS-B-17	805BS-TN-B Lite Version
A/D Sampling Rate	7.5 times/sec~960times/sec selectable			
Update Rate	50Hz or 20ms			
Internal Resolution	24 bits			
Non-linearity	≤0.005%F.S			
Zero return	≤0.1μV/ °C			
Temperature Effect	≤5ppm/°C			
Full Scale Input Signal	2~20mV			
Range of Scale Initial Signal	-1~+9mV			
Input Signal Sensitivity	0.2uV/d (minimum) 1.5uV/d (recommended)			
Zero Scale Range	±1.9%FS、±100%FS selectable			
Tare Range	0 ~ +100%FS			
Operating Temperature	-10°C ~ 40°C			
Operating Humidity	≤ 90% (without dew)			
Power Supply/ Adaptor	Input : 120VAC, 60Hz, 110mA Output : 9VDC 600mA		Input 120VAC 60HZ 110mA; Output 12VDC 400mA	
Relay Outputs	Up to 28VDC (2A) & up to 240VAC (1A)			
Load Cell Bridge Voltage	DC 5V can be connected to 16 cells of not less than 700Ω or 8 cells of not less than 350Ω			

15.4 ASCII Codes Table

ASCII	Dec	Hex	ASCII	Dec	Hex	ASCII	Dec	Hex
space	32	20	@	64	40	`	96	60
!	33	21	A	65	41	a	97	61
"	34	22	B	66	42	b	98	62
#	35	23	C	67	43	c	99	63
\$	36	24	D	68	44	d	100	64
%	37	25	E	69	45	e	101	65
&	38	26	F	70	46	f	102	66
'	39	27	G	71	47	g	103	67
(40	28	H	72	48	h	104	68
)	41	29	I	73	49	i	105	69
*	42	2A	J	74	4A	j	106	6A
+	43	2B	K	75	4B	k	107	6B
,	44	2C	L	76	4C	l	108	6C
-	45	2D	M	77	4D	m	109	6D
.	46	2E	N	78	4E	n	110	6E
/	47	2F	O	79	4F	o	111	6F
0	48	30	P	80	50	p	112	70
1	49	31	Q	81	51	q	113	71
2	50	32	R	82	52	r	114	72
3	51	33	S	83	53	s	115	73
4	52	34	T	84	54	t	116	74
5	53	35	U	85	55	u	117	75
6	54	36	V	86	56	v	118	76
7	55	37	W	87	57	w	119	77
8	56	38	X	88	58	x	120	78
9	57	39	Y	89	59	y	121	79
:	58	3A	Z	90	5A	z	122	7A
;	59	3B	[91	5B	{	123	7B
<	60	3C	\	92	5C		124	7C
=	61	3D]	93	5D	}	125	7D
>	62	3E	^	94	5E	~	126	7E
?	63	3F	_	95	5F	DEL	127	7F

15.5 Indicator Display Character

!	-	9	E	Q
“	. .	:	F	R
#	/	;	G	S
\$	0	<	H	T
%	1	=	I	U
&	2	>	J	V
'	3	?	K	W
(4	@	L	X
)	5	A	M	Y
*	6	B	N	Z
+	7	C	O	[
,	8	D	P	\

Anyload Transducer Co. Ltd

Website: www.anyload.com

Email: info@anyload.com

Fax: +1 866 612 9088

North America Toll Free: 1-855-ANYLOAD (269 5623)